

The software of this player may be updated in the future. To find out details on any available updates, please visit:

For customers in European countries  
<http://support.sony-europe.com/>

For customers in Australia  
<http://www.sony-asia.com/support/>



 To find out useful hints, tips and information about Sony products and services please visit: [www.sony-europe.com/myproduct/](http://www.sony-europe.com/myproduct/)



<http://www.sony.net/>

Printed on 70% or more recycled paper using VOC (Volatile Organic Compound)-free vegetable oil based ink.

4-145-650-11(1)



\*1-414565011\*

## Operating Instructions

Blu-ray Disc / DVD Player

BDP-S760

# WARNING

To reduce the risk of fire or electric shock, do not expose this apparatus to rain or moisture.

To avoid electrical shock, do not open the cabinet. Refer servicing to qualified personnel only.

Batteries or batteries installed apparatus shall not be exposed to excessive heat such as sunshine, fire or the like.

## CAUTION

The use of optical instruments with this product will increase eye hazard. As the laser beam used in this Blu-ray Disc/DVD player is harmful to eyes, do not attempt to disassemble the cabinet.

Refer servicing to qualified personnel only.





This label is located on the laser protective housing inside the enclosure.



This appliance is classified as a CLASS 1 LASER product. The CLASS 1 LASER PRODUCT MARKING is located on the laser protective housing inside the enclosure.

## Notice for customers in the United Kingdom and Republic of Ireland

A molded plug complying with BS1363 is fitted to this equipment for your safety and convenience. Should the fuse in the plug supplied need to be replaced, a fuse of the same rating as the supplied one and approved by ASTA or BSI to BS1362, (i.e., marked with  or ) must be used. If the plug supplied with this equipment has a detachable fuse cover, be sure to attach the fuse cover after you change the fuse. Never use the plug without the fuse cover. If you should lose the fuse cover, please contact your nearest Sony service station.



## Disposal of Old Electrical & Electronic Equipment (Applicable in the European Union and other European countries with separate collection systems)

This symbol on the product or on its packaging indicates that this product shall not be treated as household waste. Instead it shall be handed over to the applicable collection point for the recycling of electrical and electronic equipment. By ensuring this product is disposed of correctly, you will help prevent potential negative consequences for the environment and human health, which could otherwise be caused by inappropriate waste handling of this product. The recycling of materials will help to conserve natural resources. For more detailed information about recycling of this product, please contact your local Civic Office, your household waste disposal service or the shop where you purchased the product.

## For customers in Australia

The above symbol is applicable in the European Union and other European countries with separate collection systems.

Europe Only



# Pb

## Disposal of waste batteries (applicable in the European Union and other European countries with separate collection systems)

This symbol on the battery or on the packaging indicates that the battery provided with this product shall not be treated as household waste.

On certain batteries this symbol might be used in combination with a chemical symbol. The chemical symbols for mercury (Hg) or lead (Pb) are added if the battery contains more than 0.0005% mercury or 0.004% lead. By ensuring these batteries are disposed of correctly, you will help prevent potentially negative consequences for the environment and human health which could otherwise be caused by inappropriate waste handling of the battery. The recycling of the materials will help to conserve natural resources.

In case of products that for safety, performance or data integrity reasons require a permanent connection with an incorporated battery, this battery should be replaced by qualified service staff only.

To ensure that the battery will be treated properly, hand over the product at end-of-life to the applicable collection point for the recycling of electrical and electronic equipment.

For all other batteries, please view the section on how to remove the battery from the product safely. Hand the battery over to the applicable collection point for the recycling of waste batteries.

For more detailed information about recycling of this product or battery, please contact your local Civic Office, your household waste disposal service or the shop where you purchased the product.

## For customers in European countries

The manufacturer of this product is Sony Corporation, 1-7-1 Konan Minato-ku Tokyo, 108-0075 Japan. The Authorized Representative for EMC and product safety is Sony Deutschland GmbH, Hedelfinger Strasse 61, 70327 Stuttgart, Germany. For any service or guarantee matters please refer to the addresses given in separate service or guarantee documents.

## Precautions

- This unit operates on 220 V – 240 V AC, 50 Hz/60 Hz. Check that the unit's operating voltage is identical with your local power supply.
- To prevent fire or shock hazard, do not place objects filled with liquids, such as vases, on the apparatus.
- Install this unit so that the mains lead can be unplugged from the wall socket immediately in the event of trouble.

## Notes About the Discs

- To keep the disc clean, handle the disc by its edge. Do not touch the surface. Dust, fingerprints, or scratches on the disc may cause it to malfunction.



- Do not expose the disc to direct sunlight or heat sources such as hot air ducts, or leave it in a car parked in direct sunlight as the temperature may rise considerably inside the car.
- After playing, store the disc in its case.

- Clean the disc with a cleaning cloth. Wipe the disc from the centre out.



- Do not use solvents such as benzene, thinner, commercially available disc/lens cleaners, or anti-static spray intended for vinyl LPs.
- If you have printed the disc's label, dry the label before playing.
- Do not use the following discs.
  - A lens cleaning disc.
  - A disc that has a non-standard shape (e.g., card, heart).
  - A disc with a label or sticker on it.
  - A disc that has cellophane tape or sticker adhesive on it.
- Do not resurface the playing side of a disc to remove surface scratches.

## Precautions

This equipment has been tested and found to comply with the limits set out in the EMC Directive using a connection cable shorter than 3 metres.

## On safety

- To prevent fire or shock hazard, do not place objects filled with liquids, such as vases, on the player, or place the player near water, such as near a bathtub or shower room. Should any solid object or liquid fall into the cabinet, unplug the player and have it checked by qualified personnel before operating it any further.
- Do not touch the AC power cord (mains lead) with wet hands. Doing so may cause an electric shock.

## On placement

- Place the player in a location with adequate ventilation to prevent heat build-up in the player.
- Do not place the player on a soft surface such as a rug that might block the ventilation holes.
- Do not install this player in a confined space, such as a bookshelf or similar unit.
- Do not place the player in a location near heat sources, or in a place subject to direct sunlight, excessive dust, or mechanical shock.
- Do not place the player outdoors, in vehicles, on ships, or on other vessels.
- If the player is brought directly from a cold to a warm location, or is placed in a very damp room, moisture may condense on the lenses inside the player. Should this occur, the player may not operate properly. In this case, remove the disc and leave the player turned on for about half an hour until the moisture evaporates.

- Do not install the player in an inclined position. It is designed to be operated in a horizontal position only.
  - Keep the player and the discs away from equipment with strong magnets, such as microwave ovens, or large loudspeakers.
  - Do not place metal objects in front of the front panel. It may limit reception of radio waves.
  - Do not place the player in a place where medical equipment is in use. It may cause a malfunction of medical instruments.
  - If you use a pacemaker or other medical device, consult your physician or the manufacturer of your medical device before using the wireless LAN function.
  - This player should be installed and operated with a minimum distance of at least 20 cm or more between the player and a person's body (excluding extremities: hands, wrists, feet and ankles).
  - Do not place heavy or unstable objects on the player.
  - Do not place any objects other than discs on the disc tray. Doing so may cause damage to the player or the object.
  - Take out any discs when you move the player. If you don't, the disc may be damaged.
  - Disconnect the AC power cord (mains lead) and all other cables from the player when you move the player.
- Observe following points to prevent the AC power cord (mains lead) being damaged. Do not use the AC power cord (mains lead) if it is damaged, as doing so may result in an electric shock or fire.
    - Do not pinch the AC power cord (mains lead) between the player and wall, shelf, etc.
    - Do not put anything heavy on the AC power cord (mains lead) or pull on the AC power cord (mains lead) itself.

### On adjusting volume

Do not turn up the volume while listening to a section with very low level inputs or no audio signals. If you do, your ears and the speakers may be damaged when a peak level section is played.

### On cleaning

Clean the cabinet, panel, and controls with a soft cloth. Do not use any type of abrasive pad, scouring powder or solvent such as alcohol or benzine.

### On cleaning discs, disc/lens cleaners

Do not use cleaning discs or disc/lens cleaners (including wet or spray types). These may cause the apparatus to malfunction.

### On replacement of parts

In the events that this player is repaired, repaired parts may be collected for reuse or recycling purposes.

## Copyrights and Trademarks

- This product incorporates copyright protection technology that is protected by U.S. patents and other intellectual property rights. Use of this copyright protection technology must be authorized by Macrovision, and is intended for home and other limited viewing uses only unless otherwise authorized by Macrovision. Reverse engineering or disassembly is prohibited.
- "AVCHD" and the "AVCHD" logo are trademarks of Panasonic Corporation and Sony Corporation.
- Java and all Java-based trademarks and logos are trademarks or registered trademarks of Sun Microsystems, Inc.
- "XMB," "XMB," and "xross media bar" are trademarks of Sony Corporation and Sony Computer Entertainment Inc.
- This product incorporates High-Definition Multimedia Interface (HDMI™) technology. HDMI, the HDMI logo and High-Definition Multimedia Interface are trademarks or registered trademarks of HDMI Licensing LLC.
- "Blu-ray Disc" is a trademark.
- "Blu-ray Disc," "DVD+RW," "DVD-RW," "DVD+R," "DVD-R," "DVD VIDEO," and "CD" logos are trademarks.
- "BD-LIVE," "BD-LIVE" logo, and "BONUSVIEW" are trademarks of Blu-ray Disc Association.
- "x.v.Colour" and "x.v.Colour" logo are trademarks of Sony Corporation.
- "BRAVIA" is a trademark of Sony Corporation.
- "PhotoTV HD" and the "PhotoTV HD" logo are trademarks of Sony Corporation.
- The Wi-Fi CERTIFIED™ Logo is a certification mark of the Wi-Fi Alliance.

- The Wi-Fi Protected Setup™ Mark is a mark of the Wi-Fi Alliance.
- “Wi-Fi CERTIFIED™” and “Wi-Fi Protected Setup™” are trademarks of the Wi-Fi Alliance.
- DLNA®, the DLNA Logo and DLNA CERTIFIED™ are trademarks, service marks, or certification marks of the Digital Living Network Alliance.
- Microsoft and Windows are either registered trademarks or trademarks of Microsoft Corporation in the United States and/or other countries.
- Other system and product names are generally trademarks or registered trademarks of the manufacturers. ™ and ® marks are not indicated in this document.

### IMPORTANT NOTICE

Caution: This player is capable of holding a still video image or on-screen display image on your television screen indefinitely. If you leave the still video image or on-screen display image displayed on your TV for an extended period of time you risk permanent damage to your television screen. Plasma display panel televisions and projection televisions are susceptible to this.

If you have any questions or problems concerning your player, please consult your nearest Sony dealer.

## Notice for the customers in Europe



This product is intended to be used in the following countries: AD, AL, AT, BA, BE, BG, CH, CY, CZ, DE, DK, EE, ES, FI, FR, GB, GR, HR, HU, IE, IS, IT, LI, LT, LU, LV, MC, MD, ME, MK, MT, NL, NO, PL, PT, RO, RS, SE, SI, SK, SM, TR, VA

### English

Hereby, Sony Corporation declares that this BDP-S760 is in compliance with the essential requirements and other relevant provisions of Directive 1999/5/EC. For details, please access the following URL: <http://www.compliance.sony.de/>

### Français

Par la présente Sony Corporation déclare que l'appareil BDP-S760 est conforme aux exigences essentielles et aux autres dispositions pertinentes de la Directive 1999/5/CE. Pour toute information complémentaire, veuillez consulter l'URL suivante : <http://www.compliance.sony.de/>

### Deutsch

Hiermit erklärt Sony Corporation, dass sich dieser BDP-S760 in Übereinstimmung mit den grundlegenden Anforderungen und den anderen relevanten Vorschriften der Richtlinie 1999/5/EG befindet. Weitere Informationen erhältlich unter: <http://www.compliance.sony.de/>

### Italiano

Con la presente Sony Corporation dichiara che questo BDP-S760 è conforme ai requisiti essenziali ed alle altre disposizioni pertinenti stabilite dalla direttiva 1999/5/CE. Per ulteriori dettagli, si prega di consultare il seguente URL: <http://www.compliance.sony.de/>

### Nederlands

Hierbij verklaart Sony Corporation dat het toestel BDP-S760 in overeenstemming is met de essentiële eisen en de andere relevante bepalingen van richtlijn 1999/5/EG. Nadere informatie kunt u vinden op: <http://www.compliance.sony.de/>

### Español

Por medio de la presente, Sony Corporation declara que el BDP-S760 cumple con los requisitos esenciales y cualesquiera otras disposiciones aplicables o exigibles de la Directiva 1999/5/CE. Para mayor información, por favor consulte el siguiente URL: <http://www.compliance.sony.de/>

### Português

Sony Corporation declara que este BDP-S760 está conforme com os requisitos essenciais e outras provisões da Directiva 1999/5/EC. Para mais informações, por favor consulte a seguinte URL: <http://www.compliance.sony.de/>

### Svenska

Härmed intygar Sony Corporation att denna BDP-S760 står i överensstämmelse med de väsentliga egenskapskrav och övriga relevanta bestämmelser som framgår av direktiv 1999/5/EG. För ytterligare information gå in på följande hemsida: <http://www.compliance.sony.de/>

### Dansk

Undertegnede Sony Corporation erklærer herved, at følgende udstyr BDP-S760 overholder de væsentlige krav og øvrige relevante krav i direktiv 1999/5/EF. Yderligere oplysninger findes på adressen: <http://www.compliance.sony.de/>

### Suomi

Sony Corporation vakuuttaa täten, että BDP-S760 tyyppinen laite on direktiivin 1999/5/EY oleellisten vaatimusten ja sitä koskevien direktiivin muiden ehtojen mukainen. Halutessasi lisätietoja käy osoitteessa: <http://www.compliance.sony.de/>

## **Български**

С настоящето Сони Корпорация декларира, че този BDP-S760 отговаря на основните изисквания и другите съответстващи клаузи и на Директива 1999/5/EC. Подробности може да намерите на Интернет страницата: <http://www.compliance.sony.de/>

## **Česky**

Sony Corporation tímto prohlašuje, že BDP-S760 splňuje základní požadavky a další příslušná ustanovení Směrnice 1999/5/CE. Podrobnosti lze získat na následující URL: <http://www.compliance.sony.de/>

## **Eesti**

Käesolevaga Sony Corporation, teatab, et BDP-S760 on kooskõlas oluliste ja vastavate Directive 1999/5/EC tingimustega. Üksikasjalikumaks infoks kasuta palun järgnevat URL: <http://www.compliance.sony.de/>

## **Ελληνικά**

Με την παρούσα η Sony Corporation δηλώνει ότι η συσκευή BDP-S760 συμμορφώνεται προς τις ουσιώδεις απαιτήσεις και τις λοιπές σχετικές διατάξεις της οδηγίας 1999/5/ΕΚ. Για λεπτομέρειες παρακαλούμε όπως ελέγξετε την ακόλουθη σελίδα του διαδικτύου: <http://www.compliance.sony.de/>

## **Magyar**

Alulírott Sony Corporation nyilatkozik, hogy az BDP-S760 megfelel a vonatkozó alapvető követelményeknek és az 1999/5/EC irányelv egyéb előírásainak. További információkat a következő weboldalon találhat: <http://www.compliance.sony.de/>

## **Latviski**

Ar šo Sony Corporation deklarē, ka BDP-S760 atbilst Direktīvas 1999/5/EC būtiskajām prasībām un citiem ar to saistītajiem noteikumiem. Sīkākā informācija pieejama sekojošā URL: <http://www.compliance.sony.de/>

## **Lietuvių k.**

Šiuo Sony Corporation deklaruoja, kad ši BDP-S760 atitinka esminius reikalavimus ir kitas 1999/5/EB Direktivos nuostatas. Susipažinti su pilnu atitikties deklaracijos turiniu Jūs galite interneto tinklapyje: <http://www.compliance.sony.de/>

## **Norsk**

Sony Corporation erklærer herved at utstyret BDP-S760 er i samsvar med de grunnleggende krav og øvrige relevante krav i direktiv 1999/5/EF. For flere detaljer, vennligst se: <http://www.compliance.sony.de/>

## **Polski**

Niniejszym Sony Corporation oświadczam, że urządzenie BDP-S760 jest zgodne z zasadniczymi wymaganiami oraz innymi stosownymi postanowieniami Dyrektywy 1999/5/WE. Szczegółowe informacje znaleźć można pod następującym adresem URL: <http://www.compliance.sony.de/>

## **Română**

Prin prezenta, Sony Corporation declară că acest BDP-S760 respectă cerințele esențiale și este în conformitate cu prevederile Directivei 1999/5/EC. Pentru detalii, vă rugăm accesați următoarea adresă: <http://www.compliance.sony.de/>

## **Slovensky**

Sony Corporation potvrdzuje, že BDP-S760 je v zhode so základnými požiadavkami a ostatnými nariadeniami smernice 1999/5/EC. Podrobnosti získate na nasledovnej web adrese: <http://www.compliance.sony.de/>

## **Slovenščina**

Sony Corporation izjavlja, da je BDP-S760 v skladu z osnovnimi zahtevami direktive 1999/5/EC. Za podrobnosti vas naprošamo, če pogledate na URL: <http://www.compliance.sony.de/>

## **Türkçe**

İşbu Belge ile Sony Corporation BDP-S760'un 1999/5/EC Yönetmeliğinin temel gereklilikleri ve ilgili maddeleri ile uyumlu olduğunu belgeler. Detaylı bilgi için, lütfen belirtilen web sitesini ziyaret ediniz: <http://www.compliance.sony.de/>

## **Notice for the customers in France**

The WLAN feature of this BDP-S760 shall exclusively be used inside buildings.

Any use of the WLAN feature of this BDP-S760 outside of the buildings is prohibited on the French territory. Please make sure that the WLAN feature of this BDP-S760 is disabled before any use outside of the buildings. (ART Decision 2002-1009 as amended by ART Decision 03-908, relating to radio-frequencies use restrictions).

## Notice for the customers in Italy

Use of the RLAN network is governed:

- with respect to private use, by the Legislative Decree of 1.8.2003, no. 259 (“Code of Electronic Communications”). In particular Article 104 indicates when the prior obtainment of a general authorization is required and Art. 105 indicates when free use is permitted;
- with respect to the supply to the public of the RLAN access to telecom networks and services, by the Ministerial Decree of 28.5.2003, as amended, and Art. 25 (general authorization for electronic communications networks and services) of the Code of electronic communications.
- with respect to private use, by the Ministerial Decree 12.07.2007



## Notice for the customers in Cyprus

The end user must register the RLAN (or WAS or WiFi) devices in the Department of Electronic Communications (P.I. 6/2006 and P.I. 6A/2006). P.I. 6/2006 is the Radiocommunications (Categories of Stations Subject to General Authorization and Registration) Order of 2006. P.I. 6A/2006 is the General Authorization for the use of Radiofrequencies by Radio Local area Networks and by Wireless Access Systems, including Radio Local Area Networks (WAS/RLAN).

## Notice for the customers in Norway

Use of this radio equipment is not allowed in the geographical area within a radius of 20 km from the centre of Ny-Ålesund, Svalbard.

## About this manual

- In this manual, “disc” is used as a general reference for the BDs, DVDs, or CDs unless otherwise specified by the text or illustrations.
- Icons, such as **BD**, listed at the top of each explanation indicate what kind of discs can be used with the function being explained. For details, see “Playable Discs” (page 74).
- Instructions in this manual describe the controls on the remote. You can also use the controls on the player if they have the similar symbols as those on the remote.
- The on-screen display illustrations used in this manual may not match the graphics displayed on your TV screen.
- NEED-to-know information (to prevent incorrect operation) is listed under the  icon. NICE-to-know information (tips and other useful information) is listed under the  icon.

# Table of Contents

WARNING .....	2
Precautions .....	3
Guide to Parts and Controls .....	10

---

## Hookups and Settings

Hooking Up the Player .....	15
Step 1: Connecting to Your TV .....	16
Connecting to an HDMI jack .....	17
About the BRAVIA Sync features (for HDMI connections only) .....	18
Connecting to component video jacks (Y, Pb/Cb, Pr/Cr) .....	19
Connecting to audio/video or S VIDEO jacks .....	20
Step 2: Connecting to Your AV Amplifier (Receiver) .....	21
Connecting to an HDMI jack .....	22
Connecting to digital jacks (OPTICAL/COAXIAL) .....	23
Connecting to 7.1 channel jacks .....	24
Connecting to audio L/R jacks .....	25
Step 3: Inserting the External Memory .....	26
Step 4: Connecting to the Network .....	27
Step 5: Connecting the Mains Lead .....	29
Step 6: Preparing the Remote .....	29
Controlling TVs with the remote .....	30
Step 7: Easy Setup .....	31
Step 8: Setting Wireless LAN .....	33
Setting wireless LAN (Automatic registration (WPS)) .....	33
Setting wireless LAN (Access point scan) .....	34

---

## Playback

Playing BDs/DVDs .....	36
Using the BD's or DVD's menu .....	38
Enjoying BONUSVIEW/BD-LIVE .....	38
Searching for a scene quickly (Scene Search) .....	39
Searching for a Title/Chapter .....	40
Displaying the playing time and play information .....	40
Adjusting pictures and sound for videos .....	41
Playing Music CDs and MP3 Audio Tracks .....	43
Playing Photo Files .....	44
Playing from a USB device .....	46
Playing Photo Files via a Network .....	47
Preparing for the server/player .....	47
Playing photo files on a DLNA server .....	47



---

## Settings and Adjustments

Using the Settings Displays .....	48
Network Update .....	49
Video Settings .....	50
Audio Settings .....	54
BD/DVD Viewing Settings .....	59
Photo Settings .....	61
System Settings .....	61
Network Settings .....	63
Easy Setup .....	67
Resetting .....	68

---

## Additional Information

Troubleshooting .....	69
Self-Diagnosis Function .....	73
Playable Discs .....	74
Video Output Resolution .....	76
Audio Output Signals and Player Settings .....	77
About Wireless LAN Security .....	78
Specifications .....	79
Language Code List .....	80
Parental Control/Area Code .....	80
Terms and Conditions of Use and End User License Agreement .....	81
Glossary .....	83
Index .....	86

Before operating the player, please read “Terms and Conditions of Use and End User License Agreement” (page 81).

# Guide to Parts and Controls

For more information, see the pages in parentheses.

## Remote

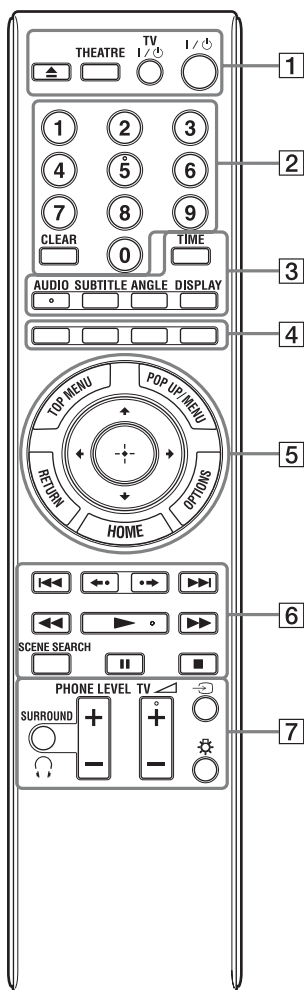

Number 5, AUDIO, ►, and TV ◀ + buttons have a tactile dot. Use the tactile dot as a reference when operating the player.



The available functions of the remote differ depending on the disc or the situation.

### 1 ▲ (open/close) (page 36)

Opens or closes the disc tray.

### THEATRE (page 18)

Switches to the optimum video mode for watching movies automatically. When connected with an AV amplifier (receiver) using the HDMI cable, the speaker output also switches automatically.

When connected with a Theatre Mode-compatible TV using the HDMI cable, the TV's video mode switches to Theatre Mode.



The THEATRE button functions only when connected to a Sony Theatre Mode-compatible AV amplifier (receiver) or Sony Theatre Mode-compatible TV.

### TV I/O (on/standby) (page 30)

Turns on the TV, or sets to standby mode.

### I/O (on/standby) (page 31)

Turns on the player, or sets to standby mode.

### 2 Number buttons (page 40, 65)

Enters the title/chapter numbers, etc.

### CLEAR

Clears the entry field.

### 3 TIME (page 13)

Displays the elapsed/remaining playback time in the front panel display. Each time you press the button, the display switches between elapsed playback time and remaining playback time.

### AUDIO (page 59)

Selects the language track when multi-lingual tracks are recorded on BD-ROMs/DVD VIDEOS.

Selects the sound track on CDs.

### SUBTITLE (page 59)

Selects the subtitle language when multi-lingual subtitles are recorded on BD-ROMs/DVD VIDEOS.

### ANGLE

Switches to other viewing angles when multi-angles are recorded on BD-ROMs/DVD VIDEOS.

## DISPLAY (page 40)

Displays the playback information on the screen.

### 4 Colour buttons (red/green/yellow/blue)

Short cut keys for selecting items on some BD's menus (can also be used for BD's Java interactive operations).

### 5 TOP MENU (page 38)

Opens or closes the BD's or DVD's Top Menu.

### POP UP/MENU (page 38)

Opens or closes the BD-ROM's Pop-up Menu, or the DVD's menu.

### OPTIONS (page 38, 45)

The options menu that can be selected appears on the screen.

### HOME (page 36, 48)

Enters the player's home menu.  
Exits the home menu when a CD is inserted.

### RETURN

Returns to the previous display.



Moves the highlight to select a displayed item.

### Centre button (ENTER)

Enters the selected item.

### 6 I◀◀/▶▶I (previous/next)

Skips to the previous/next chapter, track, or file.

To go to the beginning of the previous track, press I◀◀ twice.

### ◀-./-▶ (instant replay/instant advance)

Replays the scene/briefly fast forwards the scene.

Each time you press -./-▶, briefly fast forwards the current scenes for 15 seconds.

Each time you press ◀-., briefly replays the current scenes for 10 seconds.

### ◀◀/▶▶ (fast reverse/fast forward)

Fast reverses/fast forwards the disc when pressed during playback.

Each time you press the button, search speed changes as follows\*:

Playback direction

▶▶1 (x10) → ▶▶2 (x30) → ▶▶3 (x120)

Reverse direction

◀◀1 (x1) → ◀◀1 (x10) → ◀◀2 (x30) → ◀◀3 (x120)

When you press and hold the button, fast forward/fast reverse continues at the selected speed until you release the button.

\* Search speed does not change when playing CDs and MP3 audio tracks.

Speed multiple values are approximate.

- To resume normal playback, press ▶.

### To play in slow, freeze frame (playback direction only)

Plays BDs/DVDs in slow motion when ▶▶ is pressed for more than one second in pause mode.

Plays one frame at a time when ▶▶ is pressed briefly in pause mode.

- To resume normal playback, press ▶.

### ▶ (play) (page 36)

Starts or re-starts playback.

Resumes playback from the point where you press ■ (Resume Play).

Plays a slideshow when a disc containing JPEG image files is inserted.

### SCENE SEARCH (page 39)

Switches to Scene Search mode that lets you move quickly between scenes within the title currently being played back.



### II (pause)

Pauses or re-starts playback.





### ■ (stop)

Stops playback and remembers the stop point (resume point) (page 37, 44).

The resume point for a title/track is the last point you played or the last photo for a photo folder.

- 7**  **SURROUND (page 42)**  
Turns on or off the headphone surround mode.
- PHONE LEVEL +/- (page 42)**  
Adjusts the headphone volume when headphones are connected and a disc is being played.
- TV  (TV volume) +/- (page 30)**  
Adjusts the TV volume.



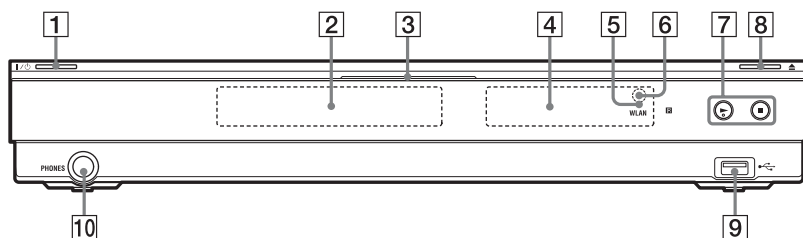

 **(input select) (page 30)**  
Switches between TV and other input sources.

 **(light)**  
Lights up the **5** and **6** buttons (except /// and ENTER) and is useful for operation in the dark.

## Front panel





The  button has a tactile dot. Use the tactile dot as a reference when operating the player.

- 1**  **(on/standby) (page 31)**  
Turns on the player, or sets to standby mode.
- 2** **Disc tray (page 36)**
- 3** **Blu-ray Disc indicator**  
Lights up in white when the player is turned on.  
Lights up in blue when playing BDs.
- 4** **Front panel display (page 13)**
- 5** **WLAN indicator**  
Lights up when “Wireless” is selected as a connection method in “Internet Settings” under the “Network Settings” setup (page 63).
- 6** **Remote sensor (page 29)**
- 7**  **(play),  (stop) (page 36)**  
Starts or stops playback.
- 8**  **(open/close) (page 36)**  
Opens or closes the disc tray.

- 9**  **USB jack (page 46)**  
Connect a USB device to this jack.
- 10** **PHONES jack (page 42)**  
Connect headphones to this jack.

### To lock the disc tray (Child Lock)

You can lock the disc tray to prevent it being opened by mistake.  
When the player is turned on, hold down  on the player for more than 10 seconds until “LOCKED” appears in the front panel display. The disc tray is locked.

To unlock the disc tray, hold down  on the player until “UNLOCK” appears in the front panel display.

## Front panel display

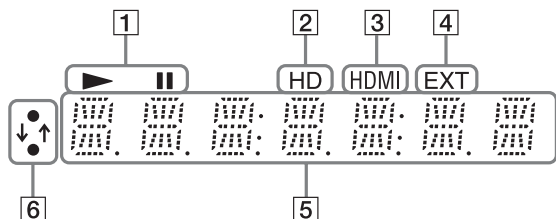

### 1 ▶, ||

Lights up during playback or pause.

### 2 HD (page 51)

Lights up when outputting 720p/1080i/1080p video signals from the HDMI OUT jack or 720p/1080i video signals from the COMPONENT VIDEO OUT jacks.

### 3 HDMI (page 17)

Lights up when an HDMI device is recognised.

### 4 EXT (page 26)

Lights up when the external memory is recognised.

### 5 Playback information

You can check the time information. Press TIME repeatedly during playback. The display changes as follows.

#### When playing a BD-ROM/DVD VIDEO

Elapsed time of the current title



Remaining time of the current title

#### When playing a CD

Elapsed time of the current track



Remaining time of the current track



Elapsed time of the current disc\*



Remaining time of the current disc\*

\* Except MP3 audio tracks



“T” (Title or Track), “C” (Chapter), or “D” (Disc) may be displayed depending on the disc.

### 6 Network connection indicator

Lights up when accessing the network and downloading the player’s software. For details on downloading the player’s software, see page 49.



The network connection indicator may not light up during the network diagnostic or other operations even when accessing the network.

## Rear panel

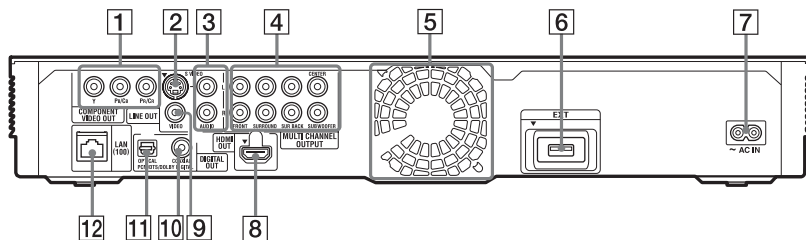

- 1 COMPONENT VIDEO OUT** (Y, PB/CB, PR/CR) jacks (page 19)
- 2 LINE OUT (S VIDEO) jack** (page 20)
- 3 LINE OUT (R-AUDIO-L) jacks** (page 19, 20, 25)
- 4 MULTI CHANNEL OUTPUT** (FRONT L/R, SURROUND L/R, SUR BACK L/R, CENTER, SUBWOOFER) jacks (page 24)
- 5 Ventilation holes**  
The ventilation fan is inside the player.
- 6 EXT slot** (page 26)
- 7 AC IN terminal** (page 29)
- 8 HDMI OUT jack** (page 17, 22)
- 9 LINE OUT (VIDEO) jack** (page 20)
- 10 DIGITAL OUT (COAXIAL) jack** (page 23)
- 11 DIGITAL OUT (OPTICAL) jack** (page 23)
- 12 LAN (100) terminal** (page 27)

---

## Hooking Up the Player

Check that you have the following items.

- Audio/video cable (phono plug ×3) (1)  
(for Australian model only)
- Mains lead (1)
- Remote commander (remote) (1)
- R6 (size AA) batteries (2)

Follow steps 1 through 8 to hook up and adjust the settings of the player. Do not connect the mains lead until you reach “Step 5: Connecting the Mains Lead” (page 29).

## Hookups and Settings

# Step 1: Connecting to Your TV

## About video/HDMI OUT jacks

The player has the following video jacks. Connect the player to your TV according to the input jacks on your TV.

When connecting the player to your TV using the HDMI cable, you can enjoy high quality digital pictures and sound through the HDMI OUT jack.

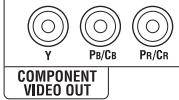
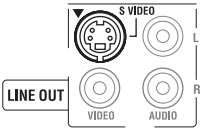
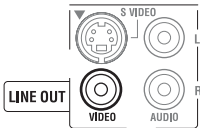
Jack type	Video resolution	Hookup
High quality Digital 	High Definition: 1080/24p, 1080p, 1080i, 720p Standard Definition: 576p/480p, 576i/480i	See "Connecting to an HDMI jack" on page 17.
Analogue 	High Definition: 1080i, 720p Standard Definition: 576p/480p, 576i/480i	See "Connecting to component video jacks (Y, Pb/Cb, Pr/Cr)" on page 19.
	Standard Definition: 576i/480i	See "Connecting to audio/video or S VIDEO jacks" on page 20.
	Standard Definition: 576i/480i	See "Connecting to audio/video or S VIDEO jacks" on page 20.



Standard quality



- Plug in cables securely to prevent unwanted noise.
- Refer to the instruction manual supplied with the components to be connected.
- You cannot connect this player to a TV that does not have a video input jack.
- Do not apply too much pressure on the connecting cables. Pushing against the cabinet wall, etc., may damage the cables or jacks.

## To connect to a TV with DVI input

Use an HDMI-DVI converter cable (not supplied). The DVI jack will not accept any audio signals, so you have to use another audio connection in addition to this connection (page 21).

Furthermore, you cannot connect the HDMI OUT jack to DVI jacks that are not HDCP compliant (e.g., DVI jacks on PC displays).



## Connecting to an HDMI jack

Connect the player and your TV using an HDMI cable to enjoy high quality digital pictures and sound through the HDMI OUT jack.

If you connect a Sony TV that is compatible with the “Control for HDMI” function (page 18), refer to the instruction manual supplied with the TV.

If you connect a 1080/24p- or 1080p-compatible TV, use a High Speed HDMI cable.

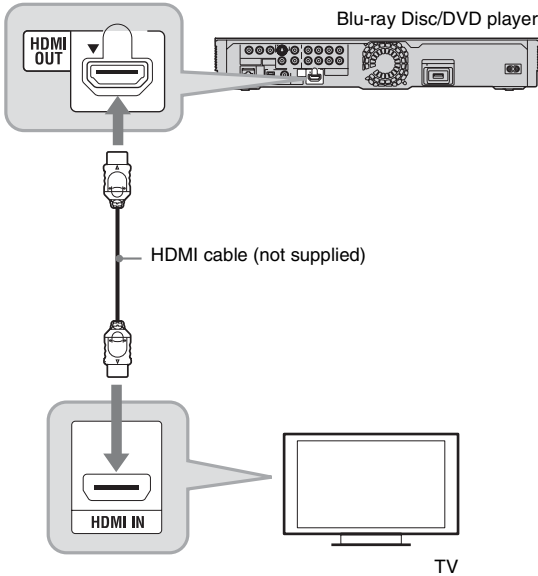

### Notes on connecting to the HDMI OUT jack

Observe the following as improper handling may damage the HDMI OUT jack and the connector.

- Carefully align the HDMI OUT jack on the rear of the player and the HDMI connector by checking their shapes. Make sure the connector is not upside down or tilted.

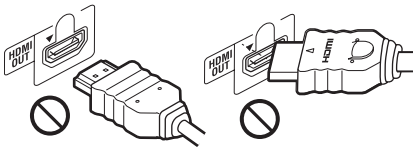

- Be sure to disconnect the HDMI cable when moving the player.



- Do not press the player against the cabinet wall when you place the player in a cabinet with the HDMI cable connected. It may damage the HDMI OUT jack or the HDMI cable.
- When connecting or disconnecting, do not screw in or rotate the HDMI connector.

### About indicators for HDMI connection

When the connected HDMI-compatible component is recognised, the HDMI indicator lights up in the front panel display.



- Not all high definition television sets are fully compatible with this product and may cause artifacts to be displayed in the picture. In the case of 480i/576i/480p/576p/720p/1080i/1080p scan picture problems, it is recommended that the user switch the connection to the LINE OUT VIDEO or S VIDEO jack. If there are questions regarding our TV set compatibility with this model 480i/576i/480p/576p/720p/1080i/1080p Blu-ray Disc/DVD player, please contact our customer service centre.
- If the picture is not clear, not natural or not to your satisfaction, change the video output resolution in step 3 of “Output Video Format” under the “Video Settings” setup (page 51).
- Be sure to use only an HDMI cable that bears the HDMI logo.

## About the BRAVIA Sync features (for HDMI connections only)

By connecting Sony components that are compatible with the “Control for HDMI” function with an HDMI cable (not supplied), operation is simplified as below:

- **One-Touch Play**  
With one touch of the following buttons, the connected TV turns on and the input selector on the TV is switched to the player automatically.
  - : HOME: The home menu appears automatically (page 11, 36, 48).
  - : Playback starts automatically (page 37).
- **System Power-Off**  
When you turn off the TV using TV or the power button on the TV’s remote, the player and HDMI-compatible components turn off automatically.
- **Theatre**  
When you press THEATRE, the player automatically switches to the optimum video mode for watching movies. When connected with a Sony AV amplifier (receiver) using the HDMI cable, the speaker output also switches automatically. When connected with a Theatre Mode-compatible TV using the HDMI cable, the TV’s video mode switches to Theatre Mode. Press the button again to return to the original setting.

- **Language Follow**

When you change the language for the on-screen display on your TV, the player’s language for the on-screen display is also changed after turning the player off and on.

### To prepare for the BRAVIA Sync features

Set “Control for HDMI” to “On” in the “System Settings” setup (page 61).

For details on settings of your TV or other connected components, refer to the instruction manual supplied with the TV or components.



- When connecting the Sony TV that is compatible with the “Control for HDMI” Easy Setting function using the HDMI cable, the “Control for HDMI” setting of the player automatically switches to “On” if the “Control for HDMI” setting on the connected TV is set to “On.” Refer to the instruction manual supplied with the TV.
- When connecting the Sony TV that is compatible with the BRAVIA Sync features using the HDMI cable, you can control the basic functions of the player with the TV’s remote if the “Control for HDMI” setting on the connected TV is set to “On.” Refer to the instruction manual supplied with the TV.



Depending on the connected component, the “Control for HDMI” function may not work. Refer to the instruction manual supplied with the component.

## Connecting to component video jacks (Y, Pb/Cb, Pr/Cr)

Connect the COMPONENT VIDEO OUT jacks of the player and your TV using a component video cable. You can enjoy high-quality pictures.  
 Be sure to connect to the LINE OUT (R-AUDIO-L) jacks using the audio/video cable.

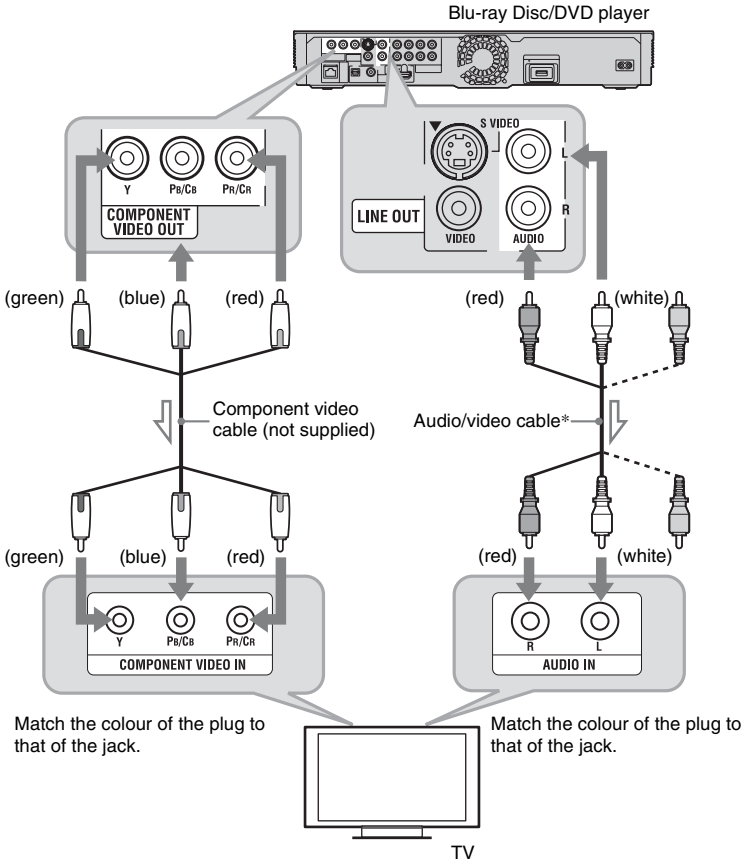

: Signal flow

\* See "Hooking Up the Player" on page 15.

When you connect the player and TV using a component video cable, disconnect the video plug (yellow) of the audio/video cable.

## Connecting to audio/video or S VIDEO jacks

Connect the LINE OUT (VIDEO, R-AUDIO-L) jacks of the player and your TV using the audio/video cable. You can enjoy standard quality pictures and sound.

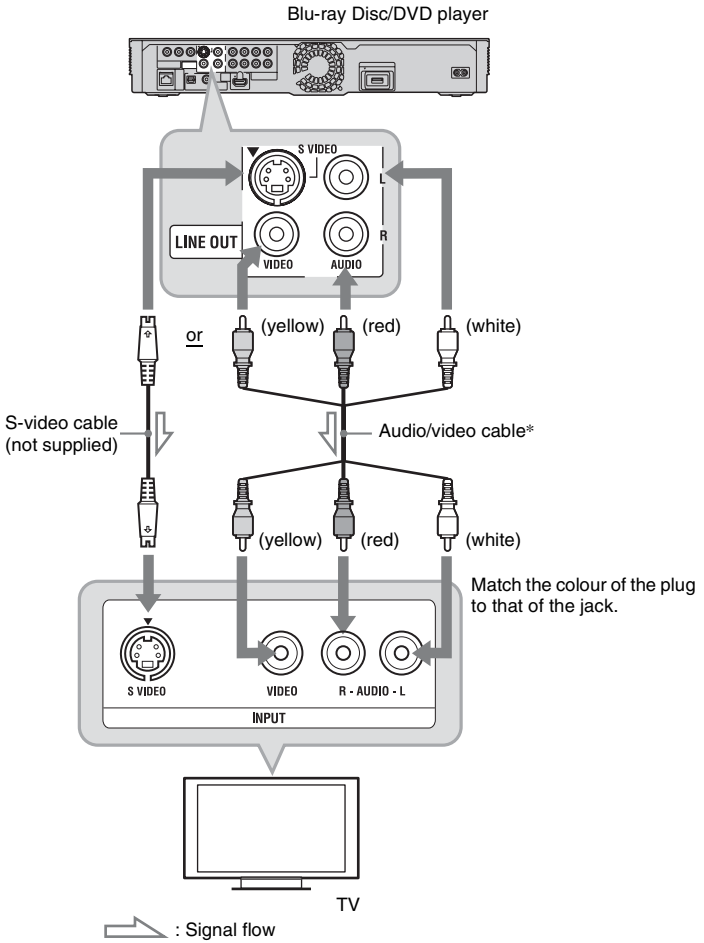

\* See "Hooking Up the Player" on page 15.







When you connect the player and TV using an S-video cable, disconnect the video plug (yellow) of the audio/video cable.

# Step 2: Connecting to Your AV Amplifier (Receiver)

## About audio/HDMI OUT jacks

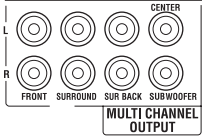
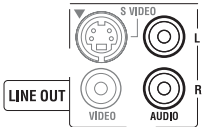
The player has the following audio jacks. Connect the player to your AV amplifier (receiver) according to the input jacks on your AV amplifier (receiver).

Jack type	Hookup
Digital 	See “Connecting to an HDMI jack” on page 22.
	See “Connecting to digital jacks (OPTICAL/COAXIAL)” on page 23.
Analogue 	See “Connecting to 7.1 channel jacks” on page 24.
	See “Connecting to audio L/R jacks” on page 25.

 For correct speaker location, refer to the instruction manual supplied with the connected components.

## Connecting to an HDMI jack

If your AV amplifier (receiver) has an HDMI input, use this connection. You can enjoy higher quality sound from the connected AV amplifier (receiver).

To enjoy 7.1 channel sound, use a High Speed HDMI cable.

If you connect a Sony AV amplifier (receiver) that is compatible with the “Control for HDMI” function (page 18), refer to the instruction manual supplied with the AV amplifier (receiver).

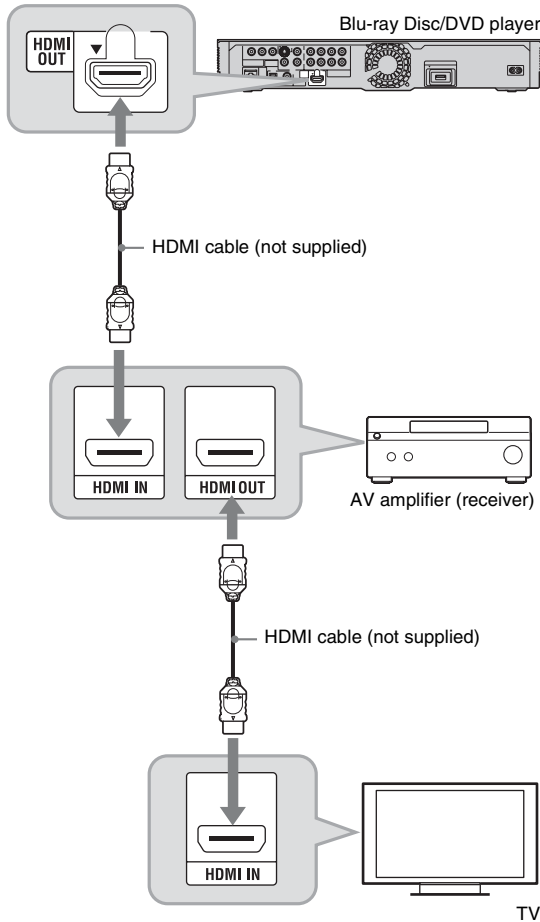

**1** Connect the HDMI OUT jack of the player and your AV amplifier (receiver).

**2** Set “BD Audio Setting” to “Direct” in the “Audio Settings” setup (page 57).

To enjoy the secondary audio (commentary), set “BD Audio Setting” to “Mix.”



Check the following settings:

- “Audio Output Priority” is set to “HDMI” in the “Audio Settings” setup (page 54).
- “Audio (HDMI)” is set to “Auto” in the “Audio Settings” setup (page 57).



Not all HDMI-compatible AV amplifiers (receivers) accept 8ch Linear PCM signals. Refer as well to instruction manual supplied with the connected AV amplifier (receiver).

## Connecting to digital jacks (OPTICAL/COAXIAL)

If your AV amplifier (receiver) has a Dolby<sup>®</sup>\*1 Digital, Dolby Pro Logic, or DTS<sup>®</sup>\*2 decoder and a digital input jack, you can enjoy Dolby Digital (5.1ch), Dolby Pro Logic (4.0ch), or DTS (5.1ch) surround effects.

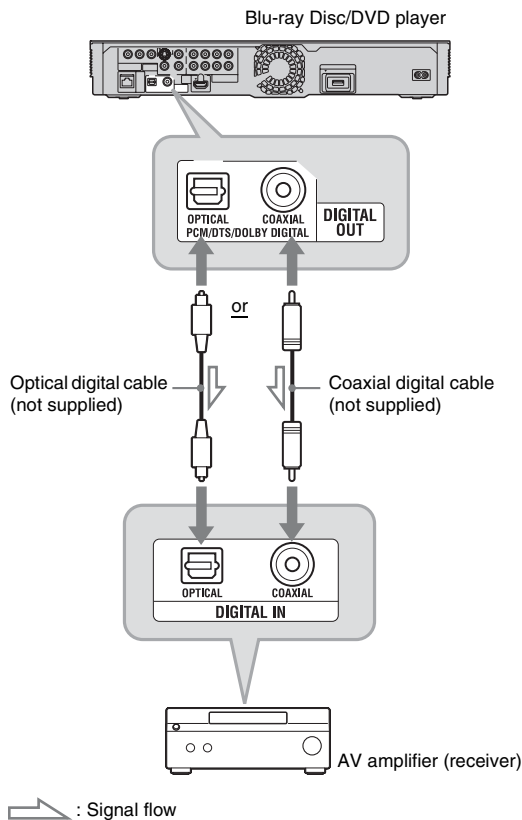

- 1** Connect the digital jack of the player and your AV amplifier (receiver).
- 2** Set “Audio Output Priority” to “Coaxial/Optical” in the “Audio Settings” setup (page 54).

- 3** Make the appropriate settings in “Dolby Digital” and “DTS” under the “Audio Settings” setup (page 57). Otherwise, no sound or a loud noise will come from your speakers.

\*1 Manufactured under license from Dolby Laboratories. Dolby, Pro Logic, and the double-D symbol are trademarks of Dolby Laboratories.

\*2 Manufactured under license under U.S. Patent #'s: 5,451,942; 5,956,674; 5,974,380; 5,978,762; 6,226,616; 6,487,535; 7,392,195; 7,272,567; 7,333,929; 7,212,872 & other U.S. and worldwide patents issued & pending. DTS is a registered trademark and the DTS logos, Symbol, DTS-HD and DTS-HD Master Audio I Essential are trademarks of DTS, Inc. © 1996-2008 DTS, Inc. All Rights Reserved.

## Connecting to 7.1 channel jacks

If your AV amplifier (receiver) has 7.1 channel inputs, you can enjoy multi channel surround sound.

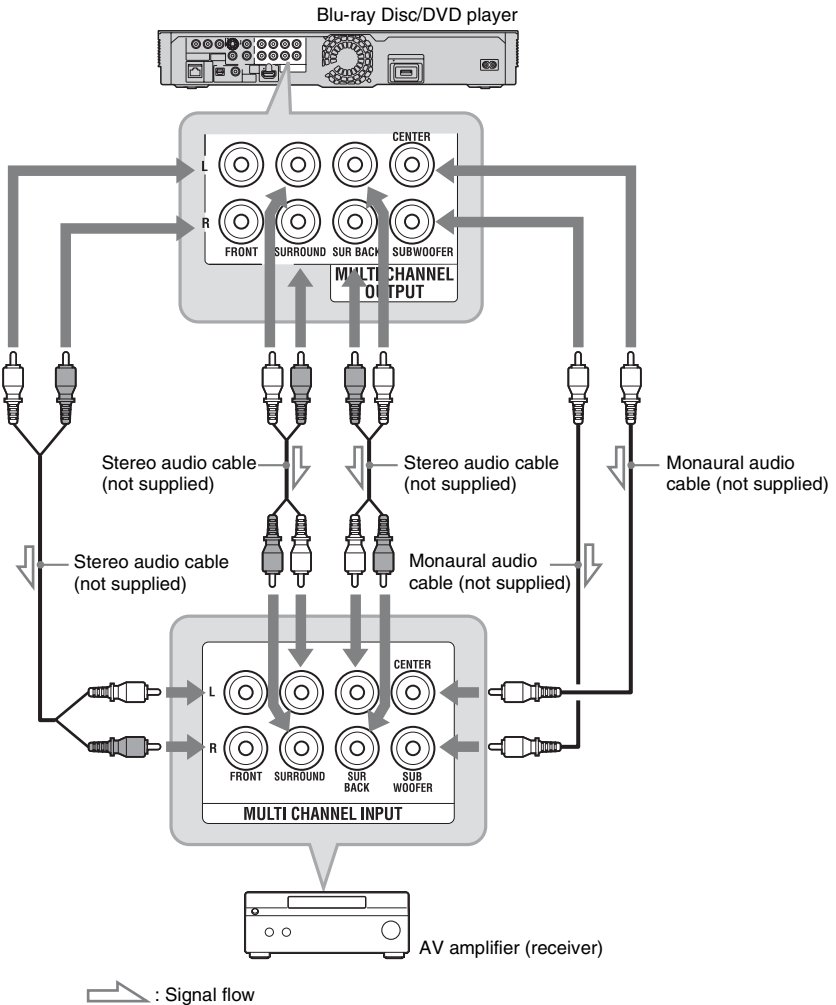



- 1** Connect the 7.1 channel jacks of the player and your AV amplifier (receiver).
- 2** Set “Audio Output Priority” to “Multi Channel Analogue” in the “Audio Settings” setup (page 54).
- 3** Make the appropriate settings in “Speaker Settings” under the “Audio Settings” setup (page 54).

## Connecting to audio L/R jacks

If your AV amplifier (receiver) only has L and R audio input jacks, use this connection.

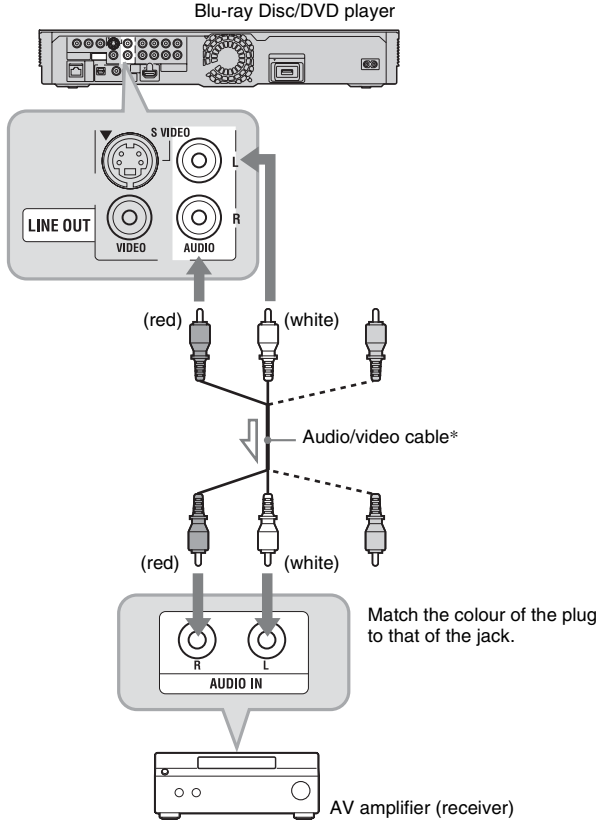

: Signal flow

\* See “Hooking Up the Player” on page 15.

---

## Step 3: Inserting the External Memory

To enjoy additional content (such as BONUSVIEW/BD-LIVE) on certain Blu-ray Disc titles, you will need to use external memory (not supplied).

Insert the external memory device (1 GB or larger USB flash memory, such as Sony USM2GL, USM4GL, or USM1GH) into the EXT slot as your local storage.



The BD-LIVE function will not be available even if you insert the external memory in the USB jack on the front panel.

### Insert the external memory into the EXT slot as far as it will go.

Check that the EXT indicator lights up in the front panel display when turning the player on.

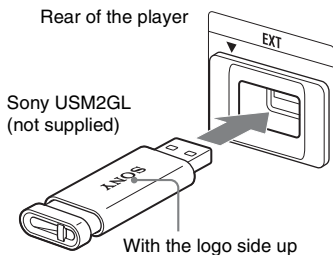

- Insert the external memory straight. If you force the external memory into the slot, this will cause damage to both the external memory and the player.
- Keep the external memory away from small children to prevent them from accidentally swallowing the external memory.
- Do not apply too much pressure to the external memory in the slot, as it may cause a malfunction.
- We recommend use of the Sony USM2GL available as of April 2009.
- Other USB flash devices may support this function. However we cannot guarantee compatibility with all USB flash memories.
- When inserting a USB flash memory, check the insertion direction before inserting it.
- Depending on the USB flash memory, it may stick out from the EXT slot. Do not force into the slot or apply pressure to the protruding portion of the USB flash memory.
- Do not connect anything other than a USB flash memory to the EXT slot.
- To avoid data corruption or damage to the external memory, turn the player off when inserting or removing the external memory.
- When the EXT indicator does not light up, turn the player off, remove and re-insert the external memory, then turn the player on again.
- Do not insert the external memory that contains photo or music files to avoid corrupting the external memory data.
- When re-formatting the USB flash memory, use FAT16 or FAT32 format.

---

### To remove the external memory

- 1 Press **I/⏻** to turn the player off.
- 2 Pull out the external memory from the EXT slot.

# Step 4: Connecting to the Network

Connect the player to your Internet source. Select the connecting method, connecting via a wireless LAN router (access point) (below) or to a broadband router directly (page 28). You can enjoy the BD-LIVE function (page 38), play photo files via a network (page 47), or update the player's software (page 49).

## 1 Connect the player to your Internet source via a wireless LAN router.

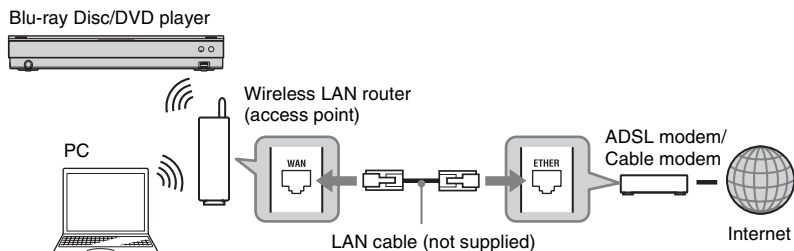

Refer also to the instruction manual supplied with the wireless LAN router.

## 2 Check your connection environment on your PC and make the appropriate settings.

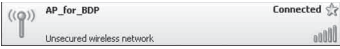
Wireless LAN router (access point)		Settings
Security Setting	Type	
Security is set. Check the security setting of your connected network on your PC screen. Example: Windows XP*1  A message with the lock icon indicates that security is enabled.	Wi-Fi Protected Setup*2-compatible  Not Wi-Fi Protected Setup-compatible	See "Setting wireless LAN (Automatic registration (WPS))" on page 33.  See "Setting wireless LAN (Access point scan)" on page 34.
No security is set.*3 Check the security setting of your connected network on your PC screen. Example: Windows XP*1  A message indicates that no security is set.	Any type	See "Setting wireless LAN (Access point scan)" on page 34.

\*1 When you use other operating systems, refer to the Help of your PC.

\*2 You can set the network settings easily with one press of the WPS button on the wireless LAN router (access point). Wi-Fi Protected Setup-compatible wireless LAN routers (access points) may have the logo ("Wi-Fi Protected Setup").

\*3 For details, see "No Security" on page 78.

## To connect a broadband router directly

- 1 Connect the LAN (100) terminal of the player to a broadband router.

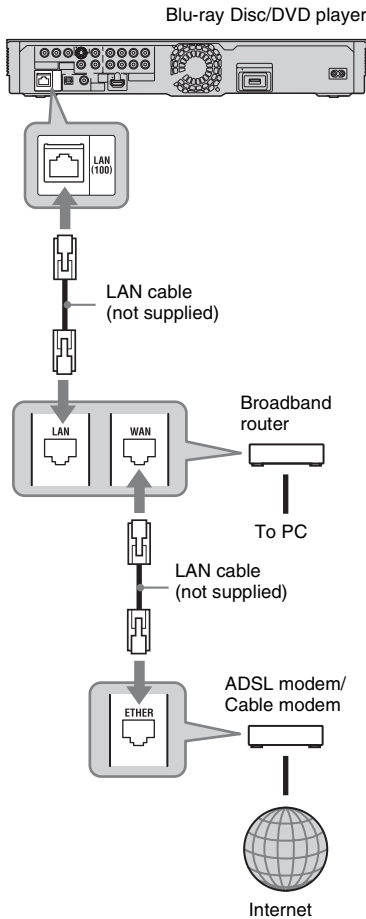

- 2 Make the appropriate settings in “Internet Settings” under the “Network Settings” setup (page 63).



- Depending on the modem or router, the type of LAN cable, straight or crossing, differs. For details on the LAN cables, refer to the instruction manual supplied with the modem or router.
- Do not connect the LAN terminal of the player to the LAN terminal of the PC.



Using a shielded interface cable (LAN cable), straight or crossing, is recommended.

## To update the player’s software using the network

See “Network Update” (page 49) and “Software Update Notification” (page 62).



Do not connect a phone line to the LAN (100) terminal, as it may cause a malfunction.

## To enjoy the BD-LIVE function

See “Enjoying BONUSVIEW/BD-LIVE” on page 38.



To enjoy the BD-LIVE function, we recommend using an Internet connection with an effective speed of 1 Mbps or greater, depending on your connection environment and network condition.

## Step 5: Connecting the Mains Lead

After all of the other connections are complete, connect the supplied mains lead to the AC IN terminal of the player. Then plug the player and TV mains leads (AC power cords) into the mains.

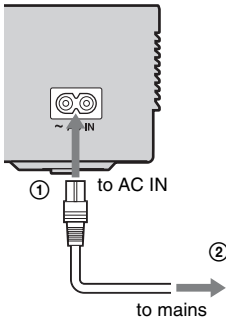

## Step 6: Preparing the Remote

You can control the player using the supplied remote. Insert two R6 (size AA) batteries by matching the ⊕ and ⊖ ends on the batteries to the markings inside the battery compartment. When using the remote, point it at the remote sensor  on the player (page 12).

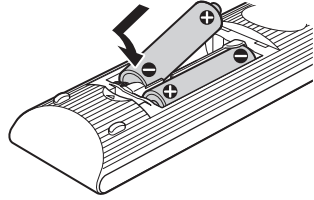

- Use the batteries correctly to avoid possible leakage and corrosion. Should leakage occur, do not touch the liquid with bare hands. Observe the following:
  - Do not use a new battery with an old battery, or batteries of different manufacturers.
  - Do not attempt to recharge the batteries.
  - If you do not intend to use the remote for an extended period of time, remove the batteries.
  - If battery leakage occurs, wipe out any liquid inside the battery compartment, and insert new batteries.
- Do not expose the remote sensor (marked  on the front panel) to strong light, such as direct sunlight or a lighting apparatus. The player may not respond to the remote.

## Controlling TVs with the remote

You can control the volume, input source, and power switch of your Sony TV with the supplied remote.



When you replace the batteries of the remote, the code number may be reset to the default setting. Set the appropriate code number again.

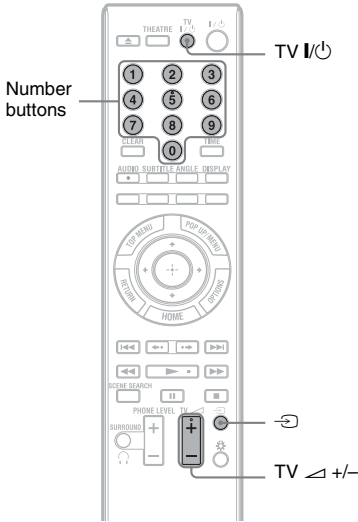

### Available buttons

Depending on the connected unit, you may not be able to control your TV with some or all of the buttons (TV I/⏻, ↻, or TV ⏻ +/-).

Buttons	Operations
TV I/⏻	Turns your TV on or off.
↻ (input select)	Switches your TV's input source between the TV and other input sources.
TV ⏻ (TV volume) +/-	Adjusts the volume of your TV.

### To control other TVs with the remote

You can control the volume, input source, and power switch of non-Sony TVs as well. If your TV is listed in the table below, set the appropriate manufacturer's code.



If you enter a new code number, the code number previously entered will be erased.

- 1 While holding down TV I/⏻, enter the TV's manufacturer code using the number buttons. For instance, to enter "09," press "0" then "9."

### Code numbers of controllable TVs

If more than one code number is listed, try entering them one at a time until you find the one that works with your TV.

Manufacturer	Code number
Sony	01 (default)
Grundig	11
Hitachi	24
ITT	15, 16
JVC	33
LG/Goldstar	76
Loewe	45
Nokia	15, 16, 69, 73
Panasonic	17, 49
Philips	06, 07, 08, 72
Saba	12, 13, 74
Samsung	22, 23, 71
Sanyo	25
Sharp	29
Telefunken	36
Thomson	43, 75
Toshiba	38

- 2 Release TV I/⏻.

# Step 7: Easy Setup

Follow the steps below to make the minimum number of basic adjustments for using the player. If you do not complete Easy Setup, it will appear each time you turn on your player. Make the settings below in the following order.

**When turned on for the first time**  
 Wait for a short while before the player turns on and starts Easy Setup.

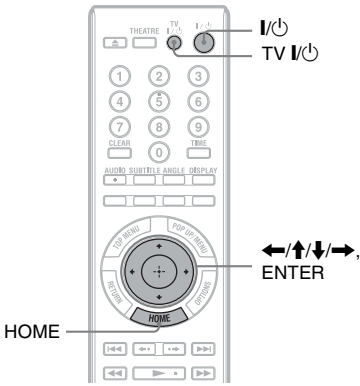

- 1 Turn on the TV.**
- 2 Press I/II to turn on the player.**  
 The player turns on after a moment.
- 3 Switch the input selector on your TV so that the signal from the player appears on your TV screen.**  
 The display for OSD language selection appears.
  - If the display for OSD language selection does not appear Press HOME, and select “Easy Setup” in the “Setup” setup (page 67). Then, select “Start,” and press ENTER.

- 4 Select a language for the on-screen displays using ↑/↓, and press ENTER.**

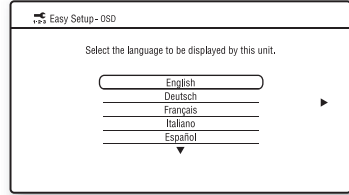

The initial settings message appears.

- 5 Select “Start,” and press ENTER.**

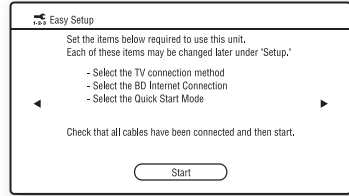

- 6 Select the cable type used to connect the player and your TV, and press ENTER.**

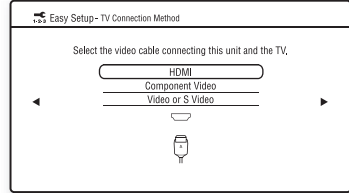

**⚡** When connecting the HDMI OUT jack and other video output jacks at the same time, select “Component Video.”

## 7 Make the appropriate settings depending on the cables connected to your TV.

### When you select “HDMI” in step 6

- ① Select “Start,” and press ENTER.  
The test screen appears for about 30 seconds.  
Example: when the video output resolution is set to 1080i

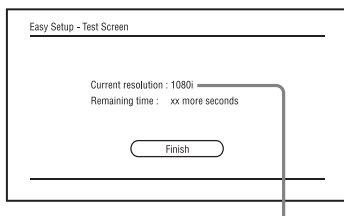

Current video output resolution setting



If no picture appears, press RETURN to return to step 6, and select “Component Video.”

- ② Select “Finish,” and press ENTER.  
The display asks for confirmation.
- ③ Select “OK” or “Cancel,” and press ENTER.

### When you select “Component Video” in step 6

- ① Select a video output resolution for the connected TV, and press ENTER.  
For details about the video output resolution, see page 52.

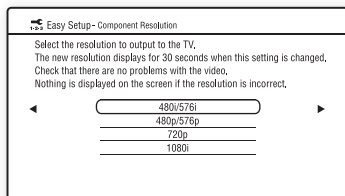

The test screen appears for about 30 seconds. For the test screen, see “When you select “HDMI” in step 6” (above).



If no picture appears, press RETURN to return to the previous screen, and change the resolution setting.

- ② Select “Finish,” and press ENTER.  
The display asks for confirmation.
- ③ Select “OK” or “Cancel,” and press ENTER.

### When you select “Video or S Video” in step 6

Select an aspect ratio that matches your TV, and press ENTER.

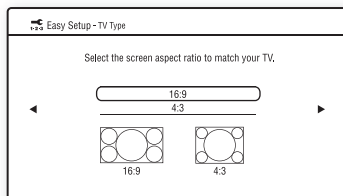

Select “16:9” when connecting to a wide-screen TV or a TV with a wide mode function.

Select “4:3” when connecting to a 4:3 screen TV without a wide mode function.

## 8 Select “Allow” to allow Internet connections from BD contents, and press ENTER.

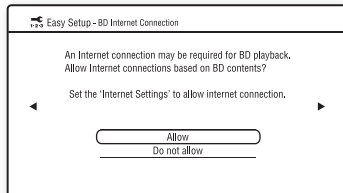

Select “Do not allow” to not allow Internet connections from BD contents.

## 9 Set “Quick Start Mode” to “On” or “Off,” and press ENTER.

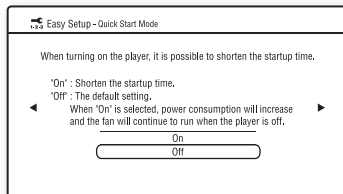

For details about “Quick Start Mode,” see page 61.



## 10 Select “Finish,” and press ENTER.

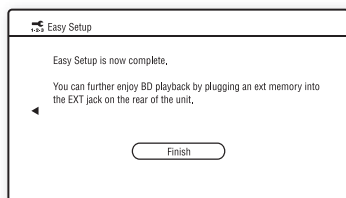

- You can reset settings to their factory settings (page 68).
- You can run “Easy Setup” again from “Easy Setup” in “Setup” (page 67).

## Step 8: Setting Wireless LAN

The network settings differ depending on your connection method or the wireless LAN router (access point). See “Step 4: Connecting to the Network” on page 27 to check the appropriate settings.

### Setting wireless LAN (Automatic registration (WPS))

Use the following procedure when you connect the player to a Wi-Fi Protected Setup-compatible wireless LAN router (access point) with security set.



The wireless settings of the wireless LAN router (access point) may change automatically if you use the Wi-Fi Protected Setup function before adjusting the settings of the wireless LAN router (access point). In this case, you may need to change the wireless settings of your PC accordingly. For details, refer to the instruction manual supplied with the wireless LAN router (access point).

- 1 Follow steps 1 and 2 of “Step 4: Connecting to the Network” on page 27.**
- 2 Press HOME.**
- 3 Select  (Setup) using  $\leftarrow/\rightarrow$ .**
- 4 Select “Internet Settings” in “Network Settings,” and press ENTER.**
- 5 Select “Start,” and press ENTER.**
- 6 Select “Wireless,” and press ENTER.**
- 7 Select “Automatic registration (WPS),” and press ENTER.**
- 8 Check the position of the WPS button on the wireless LAN router (access point) and how to press it.**

The position of the WPS button and how to press it differ depending on the wireless LAN router (access point). For details, refer to the instruction manual supplied with the wireless LAN router (access point).

**9** Select “Start,” and press ENTER.

**10** Press and hold the WPS button on the wireless LAN router (access point) until the light on the wireless LAN router (access point) starts to blink.

Press the WPS button within 2 minutes after step 9.

The message “Access point registration is complete.” appears.

Example: when the wireless LAN router (access point) has a WPS button

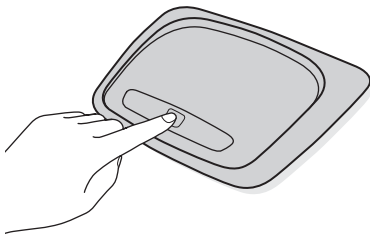

- When the player does not detect a wireless LAN router (access point), repeat from step 9 after a while.
- In some cases, depending on the security of the wireless LAN router (access point), it may not be possible to use the Wi-Fi Protected Setup function. In this case, follow the on-screen instructions, and change the settings of the wireless LAN router (access point).

**11** Select “Do not use,” and press ENTER.

If your Internet service provider has a specific proxy server setting, select “Use.” For details, see “Network Settings” on page 63.

**12** Select “Perform” using  $\uparrow/\downarrow$ , and press ENTER.

The network diagnostic starts.

Results are displayed after the player finishes the network diagnostic.

If an error message appears, follow the on-screen instructions.

For further details, visit the following website and check the FAQ contents: <http://support.sony-europe.com/>

**13** Select “Finish,” and press ENTER.

**14** Check the settings, and select “Finish,” then press ENTER.

The message “Settings are complete.” appears.

If an error message appears in the network diagnostic results, check the message. Then, set the network settings again or perform the network diagnostic again.

## Setting wireless LAN (Access point scan)

Use the following procedure when you connect the player to a wireless LAN router (access point) that is Wi-Fi Protected Setup-compatible without security set or not Wi-Fi Protected Setup-compatible.

**1** Follow steps 1 and 2 of “Step 4: Connecting to the Network” on page 27.

**2** Check the SSID and the security key on the setting screen of your wireless LAN router (access point).

For information about how to use the setting screen of the wireless LAN router (access point), visit the following website or consult the manufacturer of the wireless LAN router (access point): <http://support.sony-europe.com/>

– Security type: For details on the type of security that can be used on this player, see “About Wireless LAN Security” on page 78.

– Security key: The wireless LAN router (access point) has a WEP or WPA key according to the selected security type.



WEP or WPA key may be displayed as “passphrase” or “network key” depending on the wireless LAN router (access point).

**3** Press HOME.

**4** Select  (Setup) using  $\leftarrow/\rightarrow$ .

**5** Select “Internet Settings” in “Network Settings,” and press ENTER.

**6** Select “Start,” and press ENTER.

**7** Select “Wireless,” and press ENTER.

**8** Select “Access point scan,” and press ENTER.

The player will detect nearby access points and display the SSID (Service Set Identifier) and security settings.

**9** Select the access point with the SSID you checked in step 2, and press ENTER.

When your wireless LAN router (access point) is not detected, press RETURN and repeat from step 8 after a while. If the router is still not detected, press RETURN to select “Manual registration” in step 8. For details, see “Internet Settings” on page 63.

**10** Check the security, and press ENTER.

The display for entering WEP or WPA key appears.

- If you select “None,” go to step 13.



The appropriate security is automatically selected. You do not normally need to change the security.

**11** Press ENTER to input the WEP or WPA key.

To enter characters, see page 65.



Make sure the WEP or WPA key is correctly entered before you proceed to step 12. Once you press → in step 12, you cannot check the characters on the screen.

**12** Press →.



The WEP or WPA key is displayed as 8 asterisks no matter how many characters you enter.

**13** Select “Auto Acquisition,” and press ENTER.

If you use a static IP address, select “Manual.” For details, see “Network Settings” on page 63.

**14** Select “Auto,” and press ENTER.

If you specify a DNS server, select “Manual.” For details, see “Network Settings” on page 63.

**15** Select “Do not use,” and press ENTER.

If your Internet service provider has a specific proxy server setting, select “Use.” For details, see “Network Settings” on page 63.

**16** Select “Perform” using ↑/↓, and press ENTER.

The network diagnostic starts.

Results are displayed after the player finishes the network diagnostic.

If an error message appears, follow the on-screen instructions.

For further details, visit the following website and check the FAQ contents:

<http://support.sony-europe.com/>

**17** Select “Finish,” and press ENTER.

**18** Check the settings, and select “Finish,” then press ENTER.

The message “Settings are complete.” appears.

If an error message appears in the network diagnostic results, check the message and set the network settings again.

## Playing BDs/DVDs

BD DVD

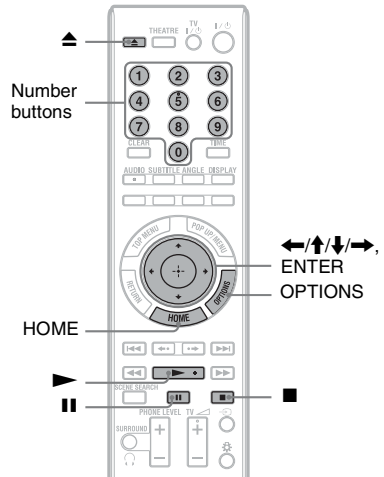

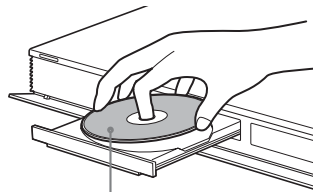

## Playback

- 1 Switch the input selector on your TV so that the signal from the player appears on your TV screen.
- 2 Press **▲**, and place a disc on the disc tray.



Playing side facing down

- 3 Press **▲** to close the disc tray.
  - When you insert a commercially available BD-ROM or DVD VIDEO, playback automatically starts depending on the disc.

- 4 Press HOME.
- 5 Select "Video" using ←/→.
- 6 Select  using ↑/↓, and press  or ENTER.

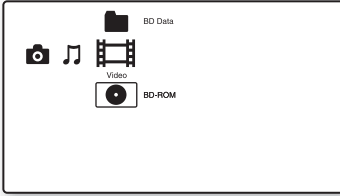

For commercially available BD-ROMs or DVD VIDEOS, playback starts. For BDs or DVDs recorded on other equipment, the title list appears. Select a title using ↑/↓, and press  or ENTER. Playback starts.

### To stop playback

Press .

### To pause playback

Press .





In the title list, "PL" (Playlist) is displayed next to the name of titles that are created and edited from their originals.



- Depending on the disc you may not be able to do some of the playback operations. Refer to the instruction manual supplied with the disc.
- Depending on BDs or DVDs recorded on other equipment, title lists or title names may not be displayed.

### To resume playback from the point where you stopped (Resume Play)

After stopping playback, select  using ↑/↓, and press  or ENTER.

The player resumes playback from the point where you pressed .

To start from the beginning, press OPTIONS to select "Play from start," and press ENTER. Playback starts from the beginning of the title.



- The point where you stopped playing is cleared from memory when:
  - you open the disc tray,
  - you play another title,
  - you change the settings on the player, or
  - you remove the external memory (for BD-ROMs).
- The player may not resume playback depending on the disc or stop point.

### To play restricted BDs or DVDs (Parental Control)

When you play a restricted BD, change the "BD Parental Control" setting in the "BD/DVD Viewing Settings" setup (page 59). When you play a restricted DVD, the display for entering your password appears on the screen.

Enter your four-digit password using the number buttons, and press ENTER. Playback starts.

To register or change the password, see "Password" (page 60).

### To play restricted BD-REs or BD-Rs (Disc Lock)

When you play a BD-RE or BD-R restricted by the Disc Lock function, the display for entering your password appears on the screen.

- 1 Enter the four-digit password that has been registered when creating the disc using the number buttons, and press ENTER.
- 2 Select a title, and press  or ENTER. Playback starts.

### One-Touch Play (for HDMI connection only)

Press .

The player and the connected TV turn on and the input selector on the TV is switched to the player, then playback starts automatically.



- When using the HDMI connection, there may be a delay before the playback picture appears on the screen, and the beginning portion of the playback picture may not be displayed.
- To use the One-Touch Play function, set "Control for HDMI" to "On" (default) in the "System Settings" setup (page 61).

## Available OPTIONS

- 1 Press **OPTIONS**.  
The options menu appears.
- 2 Select an item using **↑/↓**, and press **ENTER**.  
The available items differ depending on the disc type or player situation.

Items	Details
Headphones Type	Selects the headphones type (page 42).
Video Settings	Adjusts settings for picture (page 41).
Audio Settings	Adjusts settings for sound (page 42).
Title List	Displays the title list.
Play	Plays the title from the point where you pressed <b>■</b> .
Play from start	Plays the title from the beginning.
Top Menu	Displays the disc's Top Menu (page 38).
Menu/Popup Menu	Displays the BD-ROM's Pop-up Menu or DVD's menu (page 38).
Stop	Stops playback.
Title Search	Searches for a title and starts playback from the beginning (page 40).
Chapter Search	Searches for a chapter and starts playback from the beginning (page 40).

## Using the BD's or DVD's menu

**BD** **DVD**

### To display Top Menu

When you play a BD or DVD, you can display the Top Menu.

- 1 Press **TOP MENU** during playback.  
The Top Menu appears.
- 2 Select an item using **←/↑/↓/→**.

### To display Pop-up Menus

Some BD-ROMs contain Pop-up Menus that appear without interrupting playback.

- 1 Press **POP UP/MENU** during playback.  
The Pop-up Menu appears.
- 2 Select an item using **←/↑/↓/→**, colour buttons, or the number buttons, and follow the on-screen instructions.

## Enjoying BONUSVIEW/BD-LIVE

**BD**

Some BD-ROMs with "BD-LIVE Logo\*" have bonus contents and other data that can be downloaded to the external memory (local storage) for enjoyment.

\* **BD-LIVE™**

- 1 If a disc is inserted, remove the disc from the player.
- 2 Turn the player off.
- 3 Insert the external memory (not supplied) into the EXT slot on the rear of the player.  
The external memory is used as the local storage.  
Make sure that the external memory is properly inserted into the player (page 26).
- 4 Connect the player to a network (page 27).
- 5 Turn the player on.
- 6 Set "BD Internet Connection" to "Allow" in the "BD/DVD Viewing Settings" setup (page 60).

## 7 Insert a BD-ROM with BONUSVIEW/ BD-LIVE.

The operation method differs depending on the disc. Refer to the instruction manual supplied with the disc.

### To delete data in the external memory

You can delete unnecessary data.

- 1 If a disc is inserted, remove the disc from the player.
- 2 Press HOME.
- 3 Select "Video" using  $\leftarrow/\rightarrow$ .
- 4 Select "BD Data" using  $\uparrow/\downarrow$ , and press ENTER.
- 5 Select the disc name, and press OPTIONS.
- 6 Select "Erase," and press ENTER.
- 7 Select "OK," and press ENTER.  
The data of the selected disc will be deleted.



- To delete all data in the external memory at once, select "Erase All" in step 6.
- Press ENTER instead of OPTIONS in step 5 to skip step 6.



- The downloaded contents may not be displayed depending on the disc, if you delete the Shared Cache Data.
- Depending on the BD-ROM, the disc name may not be displayed.

## Searching for a scene quickly (Scene Search)

**BD DVD**

You can move quickly between scenes within the title currently being played back.

### 1 Press SCENE SEARCH during playback or in pause mode.

Playback pauses and a bar with a scene indicator appears at the bottom of the screen.

### 2 Move the scene indicator to the scene you are searching for using $\leftarrow/\rightarrow$ or $\lll/rrr$ .

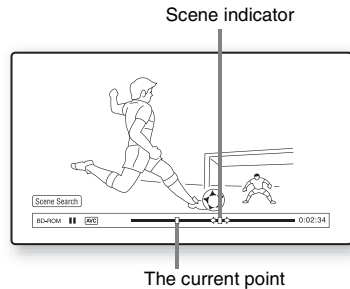

The scene indicator on the bar is displayed around the playing point.

### 3 Release the button at the point you want to watch.

The scene at which you released the button is displayed in pause mode. To search for a scene again, move the scene indicator using  $\leftarrow/\rightarrow$  or  $\lll/rrr$ .

### 4 Press SCENE SEARCH, ENTER, $\blacktriangleright$ , or $\parallel$ .

Playback starts.

### To cancel Scene Search mode

Press SCENE SEARCH, ENTER,  $\blacktriangleright$ , or  $\parallel$ . Playback starts from the point you pressed the button.



- The Scene Search function is available for titles longer than 100 seconds and shorter than 100 hours.
- The Scene Search function may not be available depending on the disc.

## Searching for a Title/Chapter

**BD DVD**

You can search for a chapter if the title contains chapter marks.

### 1 Press **OPTIONS** during playback or in pause mode.

The options menu appears.

### 2 Select a search method using **↑/↓**, and press **ENTER**.

“Title Search” (for BD-ROMs/DVD VIDEOS)

“Chapter Search”

The display for entering the number appears.

Example: Chapter Search

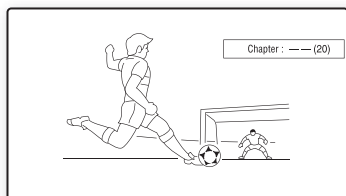

### 3 Enter the number of the title or chapter using the number buttons.

If you make a mistake, press **CLEAR**, and re-enter another number.

### 4 Press **ENTER**.

After a while, the player starts playback from the selected number.

## Displaying the playing time and playing information

**BD DVD**

You can check the title information, including the video transmission rate, etc.

### Press **DISPLAY**.

The displayed information differs depending on the disc type and player status.

Example: when playing a BD-ROM

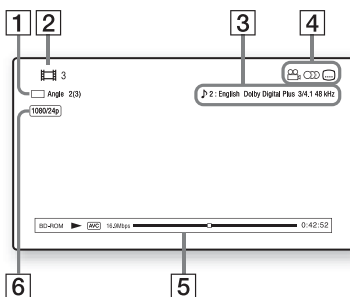

- 1 The current selected angle
- 2 Title number or name
- 3 The currently selected audio setting
- 4 Available functions (angle/ audio/subtitle)
- 5 Playback information  
Displays Disc type/Play mode/Video codec/Bit rate/Playing status bar/  
Playing time (Remaining time\*)
- 6 Output resolution/Video frequency

\* Displayed when you press **TIME** repeatedly.



- You can also check the playback information in the front panel display (page 13).
- Press **SUBTITLE**, **AUDIO**, or **ANGLE** to switch each setting.



## Adjusting pictures and sound for videos

**BD DVD**

### To adjust the picture

- 1 Press **OPTIONS** during playback. The options menu appears.
- 2 Select “Video Settings” using **↑/↓**, and press **ENTER**. The “Video Settings” screen appears.

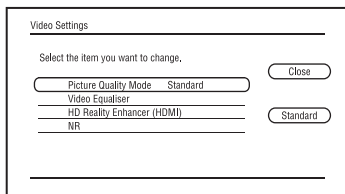

- 3 Select an item using **↑/↓**, and press **ENTER**. The default settings are underlined.

Items	Details
Picture Quality Mode ( <u>Standard</u> / Brighter Room/ Theatre Room/ Memory)	Selects the picture settings for different lighting environments.
Video Equaliser	This setting is selectable when “Picture Quality Mode” is set to “Memory” (see ““Video Equaliser” elements” on page 41).
HD Reality Enhancer (HDMI)	This setting is available only when video signals are output from the HDMI OUT jack (see ““HD Reality Enhancer (HDMI)” elements” on page 41).
NR (Noise Reduction)	Reduces the noise in the picture (see ““NR” elements” on page 42).

- 4 Select or adjust the settings using **←/↑/↓/→**, and press **ENTER**. To adjust any other items, repeat steps 3 and 4.



The “HD Reality Enhancer (HDMI)” settings are individually set during video and photo playback.



- Set the picture setting of your TV to ‘Standard’ before changing the “Picture Quality Mode” settings.
- “Video Settings” is not available when the connected TV is set to Theatre Mode (page 18).
- Depending on the disc or the scene being played, “FNR,” “BNR” or “MNR” effects may be hard to discern.

### ◆ “Video Equaliser” elements

- 1 Select “Video Equaliser” in step 3 above, and press **ENTER**.
- 2 Select an item, and press **ENTER**.

Items	Details
Contrast ( <u>(weak)</u> -3 ~ 0 ~ 3 (strong))	Changes the contrast.
Brightness ( <u>(dark)</u> -3 ~ 0 ~ 3 (bright))	Changes the overall brightness.
Chroma ( <u>(light)</u> -3 ~ 0 ~ 3 (deep))	Changes overall colour level.
Hue ((red) -3 ~ 0 ~ 3 (green))	Changes overall colour balance.
Gamma	Adjusts the picture balance between light and dark areas.

### ◆ “HD Reality Enhancer (HDMI)” elements

- 1 Select “HD Reality Enhancer (HDMI)” in step 3 above, and press **ENTER**.
- 2 Select an item, and press **ENTER**.

Items	Details
Enhance (-3 ~ <u>0</u> ~ 3)	Enhances the scene picture outline pixel by pixel.
Smoothing ( <u>Off/Standard</u> / High)	Smooths the gradation on flat parts of the picture.
FGR ( <u>0</u> ~ 3)	Reduces film grain.

## ◆ “NR” elements

- 1 Select “NR” in step 3 above, and press ENTER.
- 2 Select an item, and press ENTER.

Items	Details
FNR (Off/Auto)	Reduces random noise appearing in the picture.
BNR (Off/Auto)	Reduces mosaic-like block noise in the picture.
MNR (Off/Auto)	Reduces minor noise around the picture outlines (mosquito noise).

## To adjust the audio characteristics

- 1 Press OPTIONS during playback. The options menu appears.
- 2 Select “Audio Settings” using  $\uparrow/\downarrow$ , and press ENTER. The “Audio Settings” screen appears.

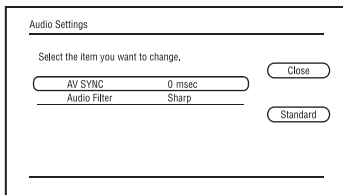

- 3 Select an item using  $\uparrow/\downarrow$ , and press ENTER. The default settings are underlined.

Items	Details
AV SYNC (short) <u>0</u> ~ 120 msec (long)	Adjusts the gap between picture and sound, by delaying the sound output in relation to the picture output (0 to 120 milliseconds).
Audio Filter (for analogue audio signals only)	<ul style="list-style-type: none"> <li>• <b>Sharp:</b> Provides a wide frequency range and spatial feeling. Normally select this.</li> <li>• <b>Slow:</b> Provides smooth and warm sound.</li> </ul>

- 4 Select or adjust the settings using  $\leftarrow/\rightarrow$ , and press ENTER. To adjust any other items, repeat steps 3 and 4.



- The “Audio Filter” function does not work for digital audio signals output from the HDMI OUT/ DIGITAL OUT (OPTICAL/COAXIAL)/ PHONES jacks.
- There may be little effect by changing the “Audio Filter” setting depending on the disc or playback environment.

## To adjust the audio characteristics for headphones

- 1 Connect your headphones.
- 2 Set “Audio Output Priority” to “Headphones” in the “Audio Settings” setup (page 54).
- 3 Press OPTIONS during playback. The options menu appears.
- 4 Select “Headphones Type” using  $\uparrow/\downarrow$ , and press ENTER.
- 5 Select “Overhead Type” or “Inner Ear Type” using  $\uparrow/\downarrow$ , and press ENTER.
- 6 Press SURROUND. “Surround (Multi)” appears on the screen, and multi channel surround sound is output. Press PHONE LEVEL +/- during playback to adjust the headphone volume. The headphone volume bar appears on the screen when pressing PHONE LEVEL +/-.



- When “Audio Output Priority” is set to other than “Headphones” in the “Audio Settings” setup, “Surround (2ch)” will appear on the screen when SURROUND is pressed. To enjoy higher quality surround sound, set “Audio Output Priority” to “Headphones” in the “Audio Settings” setup (page 54).
- When your headphones are not in use, set “Audio Output Priority” to other than “Headphones” in the “Audio Settings” setup (page 54). Otherwise, “Speaker Settings” become invalid and the recorded sound is output from the MULTI CHANNEL OUTPUT jacks as is.
- Do not use headphones at high volume, as it may cause hearing damage.
- Do not connect anything other than headphones to the PHONES jack, as it may cause a malfunction.

# Playing Music CDs and MP3 Audio Tracks

**DATA BD** \*1   **DATA DVD** \*2   **CD**   **DATA CD** \*3

- \*1 BD-REs/BD-Rs containing MP3 audio tracks
- \*2 DVD-ROMs and DVD+RWs/DVD+Rs/DVD-RWs/DVD-Rs containing MP3 audio tracks
- \*3 CD-ROMs and CD-RWs/CD-Rs containing MP3 audio tracks

## 1 Insert a music CD.

The Music Player screen appears.

## 2 Press **▶**.

Playback starts.

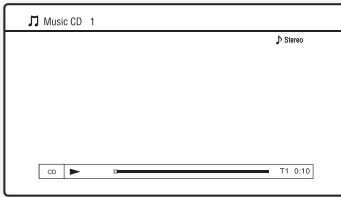

### To select a music CD track

- 1 Press HOME.
- 2 Select **♪** (Music) using **←/→**.
- 3 Select **●**, and press ENTER. The music list appears.
- 4 Select a track using **↑/↓**, and press **▶** or ENTER.

### To select an MP3 album or track

- 1 Insert a disc containing MP3 audio tracks.
- 2 Select **♪** (Music) using **←/→**.
- 3 Select **●**, and press ENTER. The list of albums and tracks appears. To play an entire disc, press **▶** instead of ENTER.
- 4 Select an album or track using **↑/↓**, and press ENTER. When you select an album, select a track in the album using **↑/↓**, and press **▶** or ENTER. To play an entire album, select the album, and press **▶**.

## Available OPTIONS

- 1 Press OPTIONS. The options menu appears.
- 2 Select an item using **↑/↓**, and press ENTER. The available items differ depending on the situation.

Items	Details
Headphones Type	Selects the headphones type (page 42).
Play	Plays the selected track.
Play from start	Plays the current track from the beginning (music CDs only).
Stop	Stops playing the track.

## Various music playback operations

Buttons	Operations
<b>▶</b>	Starts or re-starts playback. Resumes playback from the point where you pressed <b>■</b> (except MP3 audio tracks).
<b>■</b>	Stops playback.
<b>  </b>	Pauses playback.
<b>◀◀/▶▶</b>	Skips to the beginning of the current or next track. To go to the previous track press <b>◀◀</b> twice.
<b>◀◀/▶▶</b>	Fast reverses/fast forwards when pressed during playback.
TIME	Switches time information on the screen and the front panel display (page 13).
AUDIO	Selects stereo or monaural tracks (except MP3 audio tracks).
SURROUND	Turns headphone surround mode on or off (page 42).
PHONE LEVEL +/-	Adjusts the headphone volume when headphones are connected and a disc is being played (page 42).



- The point where you stopped playing (resume point) is cleared from memory when:
  - you open the disc tray, or
  - you turn off the player.
- The player can play the following MP3 audio tracks.
  - Format: MPEG-1 Audio Layer 3
  - Sampling frequency: 32 kHz/44.1 kHz/48 kHz
  - Number of channels: 2ch
  - Bit rate: 64 kbps to 320 kbps
  - File size: 1 GB Max
  - Playing time: 1 sec to 9,000 sec
  - Extension: .mp3/.MP3
  - Number of tracks: Up to 500 tracks (incl. albums if any)
- The player does not recognise the following MP3 albums/tracks.
  - MP3 albums/tracks with extremely long names
  - MP3 albums containing MP3 audio tracks with extremely long names
  - MP3 albums in the 5th tree and MP3 albums/tracks in the 6th tree or lower
- The player cannot play the following MP3 albums/tracks.
  - MP3 audio tracks recorded in monaural
  - MP3 albums/tracks recorded on BD-Rs in any format other than UDF (Universal Disk Format) 2.6
  - MP3 albums/tracks recorded on BD-REs in any format other than UDF (Universal Disk Format) 2.5
- The elapsed time of some MP3 audio tracks may not be displayed correctly.

## Playing Photo Files

**DATA BD** \*1 **DATA DVD** \*2 **DATA CD** \*3

- \*1 BD-REs/BD-Rs containing JPEG image files
- \*2 DVD-ROMs and DVD+RWs/DVD+Rs/DVD-RWs/DVD-Rs containing JPEG image files
- \*3 CD-ROMs and CD-RWs/CD-Rs containing JPEG image files

You can play photo files on a disc.

To play photo files on the connected USB device, see page 46.

To play photo files on the DLNA server, see page 47.

- 1 Press **HOME**.
- 2 Select (Photo) using **←/→**.

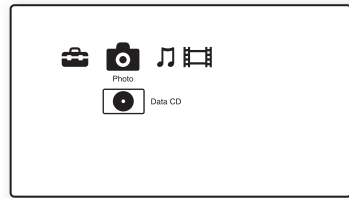

- 3 Select , and press **ENTER**.  
The file list or folder list appears.

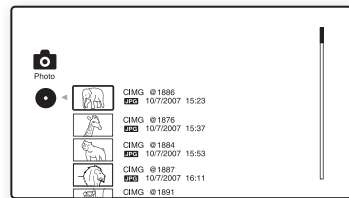

- 4 Select a file or folder using **↑/↓**, and press **ENTER**.

When you select a folder, select a file in the folder using **↑/↓**, and press **ENTER**. The selected photo file is displayed.

- To play a slideshow, press **▶**.

## Available OPTIONS during playback

- 1 Press **OPTIONS** during playback. The options menu appears.
- 2 Select an item using **↑/↓**, and press **ENTER**. The available items differ depending on the situation.

Items	Details
HD Reality Enhancer	This setting is available only when video signals are output from the HDMI OUT jack (see ““HD Reality Enhancer (HDMI)” elements” on page 45).
Slideshow Speed	Changes the slideshow speed. <ul style="list-style-type: none"> <li>• Fast</li> <li>• Normal</li> <li>• Slow</li> </ul>
Stop	Stops a slideshow.
Rotate Left	Rotates the photo counterclockwise by 90 degrees.
Rotate Right	Rotates the photo clockwise by 90 degrees.

### ◆ “HD Reality Enhancer (HDMI)” elements

- 1 Select “HD Reality Enhancer (HDMI)” in step 2 above, and press **ENTER**.
- 2 Select an item, and press **ENTER**.

Items	Details
Enhance (-3 ~ 0 ~ 3)	Enhances the scene picture outline pixel by pixel.
Smoothing (Off/Standard/High)	Smooths the gradation on flat parts of the picture.
FGR (0 ~ 3)	Reduces film grain.



The “HD Reality Enhancer (HDMI)” settings are individually set during video and photo playback.

## Various photo playback operations

Buttons	Operations
RETURN	Stops a slideshow.
	Pauses a slideshow.
	Displays the previous or next photo.
DISPLAY	Displays the file information.



- When you attempt to play the following photo files, the mark appears on the screen and they cannot be played.
  - photo files larger than 8,192 pixels (width or height)
  - photo files smaller than 15 pixels (width or height)
  - photo files exceeding 32 MB
  - photo files with extreme aspect ratios (greater than 50:1 or 1:50)
  - photo files in Progressive JPEG format
  - photo files that have a “.jpeg” or “.jpg” extension, but not in JPEG format
  - photo files that have an extremely long name
- The following photo files cannot be played.
  - photo files recorded on BD-Rs in any format other than UDF (Universal Disk Format) 2.6
  - photo files recorded on BD-REs in any format other than UDF (Universal Disk Format) 2.5
- The following photo files or folders cannot be displayed in the file list or folder list.
  - photo files that have an extension other than “.jpeg” or “.jpg”
  - photo files that have an extremely long name
  - photo folders in the 5th tree and photo files/folders in the 6th tree or lower
  - 501th or more folders when the total number of folders and files in a single tree exceeds 500
- Photo files edited on a PC may not be played.
- Thumbnail images of some photo files may not be displayed.
- Large photo files may take some time to display or to start a slideshow.

## To view best quality images

If you have a Sony TV compatible with "PhotoTV HD," you can enjoy best quality images by the following connection and setting.

- 1 Connect the player to the TV using an HDMI cable (not supplied).
- 2 Set the TV's video setting to [VIDEO-A] mode.  
For details on [VIDEO-A], refer to the instruction manual supplied with the TV.



You can enjoy "PhotoTV HD" only when "HDMI Resolution" of the player is set to "Auto," "1080i," or "1080p" in the "Output Video Format" under the "Video Settings" setup (page 52).

## Playing from a USB device

You can play photo files on the connected USB device.

### 1 Connect the USB device to the USB jack on the player.

Refer to the instruction manual supplied with the USB device before connecting.

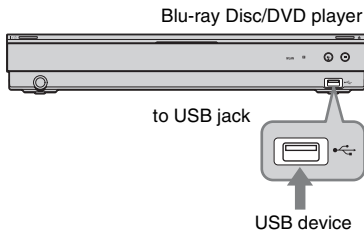

- Some USB devices may not work with this player.
- The player can recognise:
  - Mass Storage Class (MSC) devices that are FAT-compatible and non-partitioned, and
  - Still Image Capture Device (SICD) class devices.

If the MSC devices are partitioned, the player may not recognise the devices.

### 2 Press HOME.

### 3 Select (Photo) using /→.

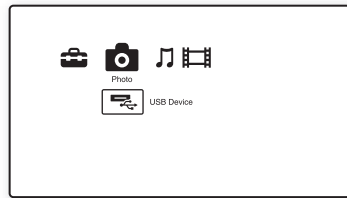

### 4 Select (USB Device) using ↓, and press ENTER.

The file list or folder list appears.

### 5 Select a file or folder using ↑/↓, and press ENTER.

When you select a folder, select a file in the folder using ↑/↓, and press ENTER. The selected photo file is displayed.

- To play a slideshow, press .



- Do not remove the USB device during operation. Stop playback and turn off the file list and folder list beforehand.
- The player cannot play photo files on a USB device if it is connected to the USB jack on the rear panel of the player.







# Playing Photo Files via a Network

You can play photo files on your home server, such as a DLNA certified PC, by connecting the player to the network of the server.

## Preparing for the server/player

See “Connection Server Settings” on page 66.

## Playing photo files on a DLNA server

- 1** Follow steps 1 through 8 of “Connection Server Settings” on page 66.
- 2** Press HOME.
- 3** Select  (Photo) using /→.
- 4** Select a DLNA server using /↓, and press ENTER.  
The file list or folder list appears.
- 5** Select a file or folder using /↓, and press ENTER.  
When you select a folder, select a file in the folder using /↓, and press ENTER.  
The selected photo file is displayed.
  - To play a slideshow, press .





- The following photo files or folders cannot be displayed in the file or folder list.
  - Photo folders in the 10th tree and photo files/folders in the 11th tree or lower
  - Folder numbers 1,000 and above when the total number of folders and files in a single tree exceeds 999
- Some server names may not be displayed.

## Settings and Adjustments

# Using the Settings Displays

Select  (Setup) on the home menu when you need to change the settings of the player.

- 1 Press HOME.
- 2 Select  (Setup) using .

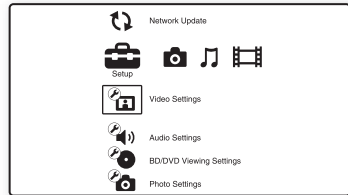

- 3 Select the setup category icon to change using , and press ENTER.

For details on setting options and setup category icons, see “Setting list” (page 49).

Example: Video Settings

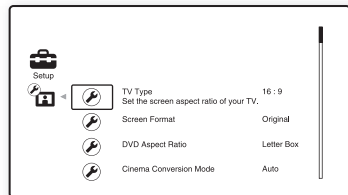









- 4 Set the options.



## Setting list

You can setup the following options.

Icon	Explanation
	<b>Network Update (page 49)</b> Updates the software of the player.
	<b>Video Settings (page 50)</b> Makes the video settings according to the type of connecting jacks.
	<b>Audio Settings (page 54)</b> Makes the audio settings according to the type of connecting jacks.
	<b>BD/DVD Viewing Settings (page 59)</b> Makes detailed settings for BD/DVD playback.
	<b>Photo Settings (page 61)</b> Makes the photo-related settings.
	<b>System Settings (page 61)</b> Makes the player-related settings.
	<b>Network Settings (page 63)</b> Makes detailed settings for Internet and network.
 1-2-3	<b>Easy Setup (page 67)</b> Re-runs the Easy Setup to make the basic settings.
	<b>Resetting (page 68)</b> Resets the player to the factory settings.

## Network Update

You can update and improve the functions of the player. We recommend the network update every 2 months or so.

For information about update functions, visit the following website:

For customers in European countries

<http://support.sony-europe.com/>

For customers in Australia

<http://www.sony-asia.com/support/>

### 1 Select “Network Update” using **↑/↓**, and press **ENTER**.

The player connects to the network, and the display asks for confirmation.

### 2 Select “OK” using **←/→**, and press **ENTER**.

The player starts downloading, then updating the software automatically. When updating finishes, “FINISH” appears for 5 seconds in the front panel display, then the player automatically turns off.

### 3 Press **I/⏻** to turn on the player.

The player starts up with the updated software.



- The “VUP \*/9” counter (“\*” indicates update step) in the front panel display also shows progress of the update.
- You can check the current software version by selecting “System Information” in the “System Settings” setup (page 62).
- The “Setup” settings remain after updating.
- The player informs you of newer software version information when “Software Update Notification” is set to “On” (default) (page 62).



- Do not disconnect the mains lead or LAN cable while downloading or updating software.
- Any operations, including opening the disc tray, are not available while updating.
- Downloading times may differ depending on the server provider or line status.
- When error messages on network connections appear, check the network settings (see “Internet Settings” on page 63).

## To update the software using an update disc

You can update and improve the functions of the player using an update disc provided by Sony dealer or local authorised Sony service facility.

- 1 Insert the update disc.  
The display asks for confirmation.
- 2 Select "OK," and press ENTER.  
Software update starts.  
When updating finishes, "FINISH" appears for 5 seconds in the front panel display, then the disc tray automatically opens.
- 3 Remove the disc.  
The player automatically turns off.
- 4 Press **I/⏻** to turn the player on.  
The player starts up with the updated software.



- The "VUP \*/9" counter ("\*" indicates update step) in the front panel display also shows progress of the update.
- You can check the current software version by selecting "System Information" in the "System Settings" setup (page 62).
- The "Setup" settings remain after updating.
- For information about other software update methods, visit the following website or consult your nearest Sony dealer or local authorised Sony Service facility:

For customers in European countries

<http://support.sony-europe.com/>

For customers in Australia

<http://www.sony-asia.com/support/>



- Do not disconnect the mains lead while updating.
- Any operations, including opening the disc tray, are not available while updating.



## Video Settings

The default settings are underlined.

### TV Type

Selects your TV type.

<u>16:9</u>	Select this when connecting to a wide-screen TV or a TV with a wide mode function.
4:3	Select this when connecting to a 4:3 screen TV without a wide mode function.

### Screen Format

Selects the display configuration for a 4:3 screen picture on a 16:9 wide screen TV.

<u>Original</u>	Select this when connecting to a TV with a wide mode function. Displays a 4:3 screen picture in 16:9 aspect ratio even on a wide-screen TV.
Fixed Aspect Ratio	Changes the picture size to fit the screen size with the original picture aspect ratio.

## DVD Aspect Ratio

Selects the display configuration for playback of 16:9 screen pictures on a 4:3 screen TV (selectable when “TV Type” is set to “4:3” and “Screen Format” is set to “Fixed Aspect Ratio”).

<u>Letter Box</u>	Displays a wide picture with black bands on the top and bottom.
<u>Pan &amp; Scan</u>	Displays a full-height picture on the entire screen, with trimmed sides.

Letter Box



Pan &amp; Scan



Depending on the DVD, “Letter Box” may be selected automatically instead of “Pan & Scan” or vice versa.

## Cinema Conversion Mode

Sets the video conversion method for 480p/576p, 720p, 1080i, or 1080p\* signals from the HDMI OUT jack or the COMPONENT VIDEO OUT jacks.

\* HDMI only

<u>Auto</u>	Normally select this. The player automatically detects whether the material is video-based or film-based, and switches to the appropriate conversion method.
<u>Video</u>	The conversion method suited for video-based material will always be selected regardless of the material.

## Output Video Format

Selects the jack type to output video signals (“TV Connection Method”) and output resolution (“HDMI Resolution”/“Component Resolution”).

- 1 Select “Output Video Format” in “Video Settings,” and press ENTER.
- 2 Select the jack type to output video signals using  $\uparrow/\downarrow$ , and press ENTER.



When connecting the HDMI OUT jack and other video output jacks at the same time, select “Component Video.”

### TV Connection Method

<u>HDMI</u>	Outputs signals from the HDMI OUT jack according to the “HDMI Resolution” setting (page 52).
<u>Component Video</u>	Outputs signals from the COMPONENT VIDEO OUT jacks according to the “Component Resolution” setting (page 52).
<u>Video or S Video</u>	Outputs signals from the LINE OUT VIDEO or S VIDEO jack.

- 3 (When you select “HDMI” or “Component Video” only)

- ① Select the signal type for the HDMI OUT jack or COMPONENT VIDEO OUT jacks using  $\uparrow/\downarrow$ , and press ENTER.

When you change the video output resolution, the test screen appears for about 30 seconds.



If no picture appears, press RETURN to return to the previous screen, and change the resolution setting.

- ② Select “Finish,” and press ENTER. The display asks for confirmation.

- ③ Select “OK” or “Cancel,” and press ENTER.

Follow the on-screen instructions.

The HD indicator lights up when outputting 720p/1080i/1080p video signals.



- If no picture appears after changing the “Output Video Format” settings, hold down **■** on the player for more than 10 seconds. The video output resolution will be reset to the lowest resolution.
- When connecting the HDMI OUT jack and other video output jacks at the same time, video signals may not output from the jacks, other than from the HDMI OUT jack, when “Auto” or “1080p” is selected (page 76). When connecting other equipment at the same time, press RETURN to return to step 2 and change the “TV Connection Method” setting.

### HDMI Resolution/Component Resolution

Auto (HDMI only)	Normally select this. The player outputs signals starting from the highest resolution acceptable to the TV: 1080p > 1080i > 720p > 480p/576p > 480i/576i. If the resulting image format is undesirable, try another setting that suits your TV.
480i/576i	Outputs 480i/576i video signals.
480p/576p	Outputs 480p/576p video signals.
720p	Outputs 720p video signals.
1080i	Outputs 1080i video signals.
1080p (HDMI only)	Outputs 1080p video signals.

### BD-ROM 1080/24p Output

Sets to output 1920 × 1080p/24 Hz video signals when playing film-based materials on BD-ROMs (720p/24 Hz or 1080p/24 Hz). 1920 × 1080p/24 Hz video signals can be output when all of the following conditions are met.

- You connect a 1080/24p-compatible TV using the HDMI OUT jack,
- “Output Video Format” is set to “HDMI,” and
- “HDMI Resolution” is set to “Auto” or “1080p.”

Auto	Outputs 1920 × 1080p/24 Hz video signals only when connecting a 1080/24p-compatible TV using the HDMI OUT jack.
On	Outputs 1920 × 1080p/24 Hz video signals regardless of the connected TV type.
Off	Select this when your TV is not compatible with 1080/24p video signals.



No BD-ROM picture appears when the connected TV is non-compatible with 1080/24p and “BD-ROM 1080/24p Output” is set to “On.” In this case, press HOME to display the home menu, and change the “BD-ROM 1080/24p Output” setting.

### YCbCr/RGB (HDMI)

Sets the colour setting for video signals output from the HDMI OUT jack. Select the setting that matches the connected TV type.

Auto	Automatically detects the connected TV type, and switches to the matching colour setting.
YCbCr (4:2:2)	Outputs YCbCr 4:2:2 video signals.
YCbCr (4:4:4)	Outputs YCbCr 4:4:4 video signals.
RGB (16-235)	Select this when connecting to a device that only supports RGB limited range.
RGB (0-255)	Select this when connecting to an RGB (0-255) device.

## HDMI Deep Colour Output

Sets the Deep Colour (colour depth) setting for video signals output from the HDMI OUT jack.

The colour depth is indicated by the number of bits, and more colours can be reproduced as the value increases. The player supports a colour depth of up to 12 bits. Connecting the player and a TV that supports Deep Colour allows more accurate colour reproduction than when connecting it to a TV that does not support Deep Colour.

<u>Auto</u>	Normally select this.
12bit	Outputs 12bit video signals.
10bit	Outputs 10bit video signals.
Off	Select this when the picture is unstable or colours appear unnatural.

## SBM

Sets whether to use the Super Bit Mapping (only for video signals output from the HDMI OUT jack).

<u>On</u>	Smooths reproduction of the video signal. Normally select this.
Off	Turns off the function.

## x.v.Colour Output

Sets whether to send xvYCC information to the connected TV.

Combining xvYCC-compatible video with a TV that supports x.v.Colour display makes it possible to more accurately reproduce object colours present in the natural world.

<u>Auto</u>	Normally select this.
Off	Select this when the picture is unstable or colours appear unnatural.

## Pause Mode

Sets the picture mode for DVD playback pause status. For BD-ROMs or discs containing AVCHD files, "Pause Mode" automatically switches to "Auto."

<u>Auto</u>	Normally select this. Dynamic moving pictures appear without blurring.
Frame	Displays static pictures at high resolution.

## Audio Settings

The default settings are underlined.

### Audio Output Priority

Selects the jack type to output audio signals. 2-channel Linear PCM signals are output at 48 kHz maximum from output jacks other than the priority jacks.

<u>HDMI</u>	Outputs audio signals from the HDMI OUT jack.
Coaxial/ Optical	Outputs audio signals from the DIGITAL OUT (OPTICAL/COAXIAL) jack.
Multi Channel Analogue	Select this when connecting an AV amplifier (receiver) via the MULTI CHANNEL OUTPUT jacks.
Stereo Analogue	Outputs audio signals from the LINE OUT (R-AUDIO-L) jacks.
Headphones	Outputs audio signals from the headphone jack (page 42).

### Speaker Settings

To obtain the best possible surround sound, set the speakers you have connected and their distance from your listening position. Then use the test tone to adjust the volume and the balance of the speakers to the same level.

This setting is selectable when “Audio Output Priority” is set to “Multi Channel Analogue.”

### To set the speakers

- 1 Select “Speaker Settings” in “Audio Settings,” and press ENTER.

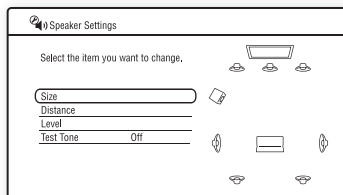

- 2 Select “Size” or “Distance,” and press ENTER.
- 3 Select a setup item using  $\uparrow/\downarrow$ , and press ENTER.
- 4 Select or set a setting using  $\uparrow/\downarrow$ , and press ENTER.

#### ◆ Size

Selects the size of the speakers.

- Front

<u>Large</u>	Normally select this position.
Small	Select this when the speakers cannot reproduce adequate low frequencies.

- Centre

<u>Large</u>	Normally select this position.
Small	Select this when the speaker cannot reproduce adequate low frequencies.
None	Select this if you do not connect a centre speaker.

- Surround

<u>Large</u>	Normally select this position.
Small	Select this when the speakers cannot reproduce adequate low frequencies.
None	Select this if you do not connect surround speakers.

• Surround Back

<u>Large</u>	Normally select this position.
Small	Select this when the speakers cannot reproduce adequate low frequencies.
None	Select this if you do not connect surround back speakers.

• Subwoofer

<u>Yes</u>	Select this if you connect a subwoofer to output the LFE (low frequency effect) signals from the subwoofer.
None	Select this if you do not connect a subwoofer.



- When you play a BD or DVD that does not have subwoofer output recorded, no sound is produced from the subwoofer, even if “Subwoofer” is set to “Yes.”
- Since subwoofer use is set as the player default setting, “Subwoofer” cannot be set to “None” when “Front” is set to “Small.”
- When connecting the front speakers that cannot reproduce adequate low frequencies and a subwoofer is not connected, set “Front” to “Large,” and “Subwoofer” to “None.”

◆ **Distance**

Sets the distance from your listening position to the speakers.

Set the distance to your front speakers in “Front” first (A = 1.0 m to 15.0 m). Then adjust the values in “Centre” (centre speaker B), “Surround” (surround speakers C), “Surround Back” (surround back speakers D), and “Subwoofer” (E) to reflect the actual distance to your centre speaker, surround speakers, surround back speakers, and subwoofer.

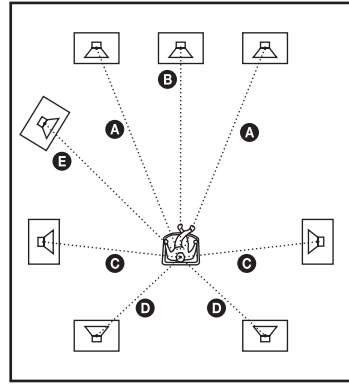

Change the “Distance” setting each time you move the speakers. Start from the front speakers.

<u>Front</u> (3.0 [m])	Set this between 1.0 metre and 15.0 metres in 0.2 metre increments.
<u>Centre</u> (3.0 [m])	Set this within -1.6 metres and +0.6 metre of the “Front” setting (0 to 15.6 metres, 0.2 metre increments). For example, if “Front” is set to 1.6 metres, “Centre” can be set between 0 metre and 2.2 metres.
<u>Surround</u> (3.0 [m])	Set this within -5.0 metres and +0.6 metre of the “Front” setting (0 to 15.6 metres, 0.2 metre increments). For example, if “Front” is set to 5.0 metres, “Surround” can be set between 0 metre and 5.6 metres.

Surround Back (3.0 [m])	Set this within -5.0 metres and +0.6 metre of the "Front" setting (0 to 15.6 metres, 0.2 metre increments). For example, if "Front" is set to 5.0 metres, "Surround Back" can be set between 0 metre and 5.6 metres.
Subwoofer (3.0 [m])	Set this within -1.6 metres and +0.6 metre of the "Front" setting (0 to 15.6 metres, 0.2 metre increments). For example, if "Front" is set to 1.6 metres, "Subwoofer" can be set between 0 metre and 2.2 metres.

### To adjust the speaker level

- 1 Select "Speaker Settings" in "Audio Settings," and press ENTER.
- 2 Select "Test Tone" using  $\uparrow/\downarrow$ , and press ENTER.
- 3 Select "On" using  $\uparrow/\downarrow$ , and press ENTER.  
You will hear the test tone from each speaker in sequence.
- 4 From your listening position, adjust the value of "Level" using  $\leftarrow/\uparrow/\downarrow/\rightarrow$ .  
The test tone is emitted from the selected speaker.
- 5 Press ENTER when you finish adjusting.
- 6 Press RETURN to return to the previous screen.
- 7 Select "Test Tone" using  $\uparrow/\downarrow$ , and press ENTER.
- 8 Select "Off" using  $\uparrow/\downarrow$ , and press ENTER.



To adjust the level without listening to the test tone, select "Level" in step 2 and press ENTER, then adjust the level using  $\uparrow/\downarrow$ , and press ENTER.

### ◆ Level

You can vary the level of each speaker as follows. Be sure to set "Test Tone" to "On" for easy adjustment.

Front Left Front Right (0.0 [dB])	Adjust the level of the front speakers (-12.0 dB to 0.0 dB, 0.5 dB increments).
Centre (0.0 [dB])	Adjust the level of the centre speaker (-12.0 dB to 0.0 dB, 0.5 dB increments).
Surround Left Surround Right (0.0 [dB])	Adjust the level of the surround speakers (-12.0 dB to 0.0 dB, 0.5 dB increments).
Surround Back Left Surround Back Right (0.0 [dB])	Adjust the level of the surround back speakers (-12.0 dB to 0.0 dB, 0.5 dB increments).
Subwoofer (0.0 [dB])	Adjust the level of the subwoofer (-12.0 dB to 0.0 dB, 0.5 dB increments).

### ◆ Test Tone

On	The player emits a test tone in sequence from the MULTI CHANNEL OUTPUT jacks to adjust the sound level from each speaker. When you select one of the "Speaker Settings" items, the test tone is emitted from the selected speaker.
Off	The test tone is not emitted from the speakers.



## Audio (HDMI)

Selects the signal type for the HDMI OUT jack.

<u>Auto</u>	Normally select this. Outputs audio signals according to the status of the connected HDMI device.
2ch PCM	Downmixes to 2-channel Linear PCM signals before outputting from the HDMI OUT jack.



Select “2ch PCM” when connecting a TV or an AV amplifier (receiver) that does not support Dolby Digital or DTS, otherwise noise or no sound may result.

## BD Audio Setting

Selects whether to mix or not mix interactive audio and secondary audio (commentary) when playing a BD that contains such audio.

<u>Mix</u>	Outputs the audio obtained by mixing the interactive audio and secondary audio to the primary audio.
Direct	Outputs the primary audio only.



PCM 96 kHz and PCM 192 kHz audio signals are output as PCM 48 kHz audio signals when “BD Audio Setting” is set to “Mix.”

## Audio ATT

Lowers the audio output level to prevent sound distortion.

On	Enables Audio Attenuation.
<u>Off</u>	Disables Audio Attenuation.



“Audio ATT” does not affect the output from the HDMI OUT jack, the DIGITAL OUT (OPTICAL/COAXIAL) jack, and the PHONES jack.

## Dolby Digital

Selects the audio signals output when playing Dolby Digital discs.

This setting affects the output from the DIGITAL OUT (COAXIAL/OPTICAL) jack.

Downmix PCM	Converts to output Linear PCM signals. Select this when connecting an audio device without a built-in Dolby Digital decoder.
<u>Dolby Digital</u>	Select this when connecting an audio device with a built-in Dolby Digital decoder.

## DTS

Selects the audio signals output when playing DTS discs. This setting affects the output from the DIGITAL OUT (COAXIAL/OPTICAL) jack.

Downmix PCM	Converts to output Linear PCM signals. Select this when connecting to an audio device without a built-in DTS decoder.
<u>DTS</u>	Select this when connecting to an audio device with a built-in DTS decoder.

## 48kHz/96kHz PCM

Selects the maximum sampling frequency for the PCM signals output from the DIGITAL OUT (OPTICAL/COAXIAL) jack.

<u>48kHz/16bit</u>	Outputs audio signals of 96 kHz sampling as 48 kHz/16 bit.
96kHz/24bit	Outputs audio signals of 96 kHz sampling as 96 kHz/24 bit. However, the signals will be output as 48 kHz/16 bit if the source is copy-protected.



- If you select “96kHz/24bit” when an AV amplifier (receiver) that does not support 96 kHz is connected, no sound or a loud sound may result.
- “48kHz/96kHz PCM” is not effective when “Audio Output Priority” is set to “HDMI,” “Multi Channel Analogue,” or “Stereo Analogue.”

## Audio DRC

Selects the dynamic range (compression level of the sound) setting when playing a BD or DVD that conforms to “Audio DRC.”

<u>Auto</u>	Performs playback at the dynamic range specified by the disc (BD-ROM only). Other discs are played back at the “Standard” level.
Standard	Performs playback at a compression level between “TV Mode” and “Wide Range.”
TV Mode	Sounds are compressed heavily. Low sounds are easier to hear.
Wide Range	No compression works. A more dynamic sound is produced.



- “Audio DRC” is effective only when playing Dolby Digital, Dolby Digital Plus, and Dolby TrueHD audio signals.
- When “Dolby Digital” is set to “Dolby Digital” in the “Audio Settings” setup (page 57), “Audio DRC” has no effect on the audio output from the DIGITAL OUT (OPTICAL/COAXIAL) jack. However, this excludes the following cases.
  - when “BD Audio Setting” is set to “Mix” when playing a BD.
  - when “Audio Output Priority” is set to “HDMI,” “Multi Channel Analogue,” “Stereo Analogue,” or “Headphones.”

## Downmix

Sets the downmix method of multi-channel to two-channel sound.

<u>Dolby Surround</u>	Outputs the Dolby Surround (Pro Logic) signals in 2 channels. Select this when connecting an audio device that supports Dolby Surround (Pro Logic).
Normal	Outputs audio signals without Dolby Surround (Pro Logic) effect. Select this when connecting an audio device that does not support Dolby Surround (Pro Logic).



“Downmix” has no effect on the bitstream audio output from the DIGITAL OUT (OPTICAL/COAXIAL)/HDMI OUT jack.

## BD/DVD Viewing Settings

The default settings are underlined.

### BD/DVD Menu

Selects the default menu language for BD-ROMs or DVD VIDEOS.

When you select “Select Language Code,” the display for entering the language code appears. Enter the code for your language by referring to “Language Code List” (page 80).

### Audio

Selects the default track language for BD-ROMs or DVD VIDEOS.

When you select “Original,” the language given priority in the disc is selected.

When you select “Select Language Code,” the display for entering the language code appears. Enter the code for your language by referring to “Language Code List” (page 80).

### Subtitle

Selects the default subtitle language for BD-ROMs or DVD VIDEOS.

When you select “Select Language Code,” the display for entering the language code appears. Enter the code for your language by referring to “Language Code List” (page 80).





### BD Parental Control

Playback of some BD-ROMs can be limited according to the age of the users. Scenes may be blocked or replaced with different scenes.

- 1** Select “BD Parental Control” in “BD/DVD Viewing Settings,” and press ENTER.
- 2** Enter your four-digit password using the number buttons.
- 3** Select “OK,” and press ENTER.

- 4** Select the age restriction, and press ENTER.

The lower the value, the stricter the limitation.

If you select “Select Age Restriction,” you can enter the age from “0” to “255” using /// or the number buttons.

- To cancel the Parental Control setting, select “No Restrictions.”



You can change the password (see “Password” on page 60).



- If you forget the password, reset the player (page 68) and set a new password (see “Password” on page 60).
- When you play discs which do not have the Parental Control function, playback cannot be limited on this player.
- Depending on the disc, you may be asked to change the Parental Control level while playing the disc. In this case, enter your password, then change the level.
- When “255” is selected in “Select Age Restriction,” the Parental Control setting is cancelled.

### DVD Parental Control

Playback of some DVD VIDEOS can be limited according to the age of the users. Scenes may be blocked or replaced with different scenes.

- 1** Select “DVD Parental Control” in “BD/DVD Viewing Settings,” and press ENTER.
- 2** Enter your four-digit password using the number buttons.
- 3** Select “OK,” and press ENTER.
- 4** Select a level, and press ENTER.  
The lower the value, the stricter the limitation.
  - To cancel the Parental Control setting, select “No Restrictions.”



You can change the password (see “Password” on page 60).



- If you forget the password, reset the player (page 68) and set a new password (see “Password” on page 60).
- When you play discs which do not have the Parental Control function, playback cannot be limited on this player.
- Depending on the disc, you may be asked to change the Parental Control level while playing the disc. In this case, enter your password, then change the level.

## Parental Control Region Code

Playback of some BD-ROMs or DVD VIDEOS can be limited according to the geographic area. Scenes may be blocked or replaced with different scenes.

- 1 Select “Parental Control Region Code” in “BD/DVD Viewing Settings,” and press ENTER.**
- 2 Enter your four-digit password using the number buttons.**
- 3 Select “OK,” and press ENTER.**
- 4 Select the area restriction, and press ENTER.**

When you select “Select Region Code,” the display for entering the region code appears. Enter the code for the area restriction by referring to “Parental Control/Area Code” (page 80).



You can change the password (see “Password” on page 60).



- If you forget the password, reset the player (page 68) and set a new password (see “Password” on page 60).
- When you play discs which do not have the Parental Control function, playback cannot be limited on this player.
- Depending on the disc, you may be asked to change the Parental Control level while playing the disc. In this case, enter your password, then change the level.

## Password

Sets or changes the password for the Parental Control function. A password allows you to set a restriction on BD-ROM or DVD VIDEO playback. If necessary, you can differentiate the restriction levels for BD-ROMs and DVD VIDEOS.

- 1 Select “Password” in “BD/DVD Viewing Settings,” and press ENTER.**
- 2 Enter your four-digit password using the number buttons.**
- 3 Select “OK,” and press ENTER.**

### To change the password

- 1** After step 3, enter a new password using the number buttons.
- 2** Select “OK,” and press ENTER.

## Hybrid Disc Playback Layer

Selects the layer priority when playing a Hybrid Disc. To change the setting, turn the player off and on again.

<u>BD</u>	Plays BD layer.
DVD/CD	Plays DVD or CD layer.

## BD Internet Connection

Sets whether to allow Internet connections from the contents of a BD (in BDMV mode) being played. Network connections and settings are required when using this function (page 63).

<u>Allow</u>	Normally select this.
<u>Do not allow</u>	Prohibits Internet connection.



## Photo Settings

The default setting is underlined.

### Slideshow Speed

Changes the slideshow speed.

Fast	Photos change rapidly.
<u>Normal</u>	Photos change at normal speed.
Slow	Photos change slowly.



## System Settings

The default settings are underlined.

### OSD

Selects your language for the player on-screen displays.

### Dimmer

Adjusts the lighting of the front panel display.

<u>Bright</u>	Bright lighting.
Dark	Low lighting.
Off	Turns off the lighting during playback. Low lighting other than during playback.

### Control for HDMI

<u>On</u>	Allows you to use the “Control for HDMI” function (page 18).
Off	Turns off the function.

### Quick Start Mode

On	Shortens the startup time when turning on the player.
<u>Off</u>	The default setting.



When “Quick Start Mode” is set to “On,”

- power consumption will be higher than when “Quick Start Mode” is set to “Off” and
- the ventilation fan may turn on depending on the surrounding temperature.

## Auto Power Off

The player automatically turns off if you do not press any of the buttons on the player or remote for more than 30 minutes, unless you are playing BDs/DVDs/CDs/photo files or are updating software.

On	Turns on the "Auto Power Off" function.
Off	Turns off the function.

## Auto Display

On	Automatically displays information on the screen when changing the viewing titles, picture modes, audio signals, etc.
Off	Displays information only when you press DISPLAY.

## Screen Saver

The screen saver image appears when you do not use the player for more than 15 minutes while an on-screen display, such as the home menu, is displayed on your TV screen. The screen saver image helps prevent your display device from becoming damaged (ghosting).

On	Turns on the screen saver function.
Off	Turns off the function.

## Software Update Notification

Informs you of newer software version information. Network connections and settings are required when using this function (page 63).

On	Sets the player to inform you of newer software version information (page 49).
Off	Turns off the function.

## System Information

Displays the player's software version information and the MAC address.



# Network Settings

## Internet Settings

These items are necessary when you connect the player to the Internet. Enter the respective (alphanumeric) values for your broadband router or wireless LAN router.

The items that need to be set may differ, depending on the Internet service provider or the router. For details, refer to the instruction manuals that have been provided by your Internet service provider or supplied with the router.

- 1** Select “Internet Settings” in “Network Settings,” and press ENTER.
- 2** Select “Start,” and press ENTER.
- 3** Select the connected router type, and press ENTER.

Wireless	Select this when connecting via a wireless LAN router (access point).
<u>Wired</u>	Select this when connecting to a broadband router directly, and go to step 10.

- 4** Select the configuration method of wireless LAN, and press ENTER.

Automatic registration (WPS)	When you connect the player to a Wi-Fi Protected Setup-compatible wireless LAN router (access point) with security set, select this and go to step 7 of “Setting wireless LAN (Automatic registration (WPS))” on page 33.
<u>Access point scan</u>	Select this when you connect the player to a wireless LAN router (access point) that is Wi-Fi Protected Setup-compatible without security set or not Wi-Fi Protected Setup-compatible.
Manual registration	Select this to make all the settings manually.

- 5** Check the following settings of your wireless LAN router (access point).

- SSID (Service Set Identifier)
- Security type: For details on which security can be used on this player, see “About Wireless LAN Security” on page 78.
- Security key: The wireless LAN router (access point) has a WEP or WPA key according to the selected security type.
- When you select “Access point scan” in step 4, go to step 9 of “Setting wireless LAN (Access point scan)” on page 34.



- WEP or WPA key may be displayed as “passphrase” or “network key” depending on the wireless LAN router (access point).
- The SSID of your wireless LAN router (access point) is displayed in the wireless network list on your PC. Check your connected network SSID on page 27.

## 6 Select the manual registration method, and press ENTER.

<u>Manual registration</u>	To make all the settings manually, select this and enter SSID. To enter characters, see page 65.
(WPS) PIN method	Select this when you connect the player to a Wi-Fi Protected Setup-compatible wireless LAN router (access point) and use a PIN code.

- When you select “(WPS) PIN method,” the PIN code of this player appears. Register the code to the wireless LAN router (access point) within 2 minutes after pressing “Start,” and go to step 12. For details on the registration, refer to the instruction manual supplied with the wireless LAN router (access point).

## 7 Select the security, and press ENTER.

The display for entering WEP or WPA key appears.

- If you select “None,” go to step 10.

## 8 Press ENTER to input the WEP or WPA key.

To enter characters, see page 65.



Make sure the WEP or WPA key is correctly entered before you proceed to step 9. Once you press → in step 9, you cannot check the characters on the screen.

## 9 Press →.



The WEP or WPA key is displayed as 8 asterisks no matter how many characters you enter.

## 10 Select the IP address setting method, and press ENTER.

<u>Auto Acquisition</u>	Select this when DHCP (Dynamic Host Configuration Protocol) server settings are available from your Internet service provider. The network settings necessary for the player will be assigned automatically.
Manual	Set the IP address manually according to your network environment.

- When you select “Manual,” set the following items:

- IP Address
- Subnet Mask
- Default Gateway

The display for the DNS server setting appears after you set the items.

Enter the DNS server address manually, and go to step 12.

## 11 Select the DNS server setting method, and press ENTER.

<u>Auto</u>	Acquires the DNS server address automatically.
Manual	Enter the DNS server address manually.

- When you select “Manual,” enter the address in the “Primary DNS” row.

## 12 Select “Do not use,” and press ENTER.

If your Internet service provider has a specific proxy server setting, select “Use,” and fill the “Proxy Server” and “Port Number” rows. To enter characters, see page 65.



### 13 Select “Perform” using $\uparrow/\downarrow$ , and press ENTER.

The network diagnostic starts. Results are displayed after the player finishes the network diagnostic. If an error message appears, follow the on-screen instructions.

For further details, visit the following website and check the FAQ contents: <http://support.sony-europe.com/>

### 14 Select “Finish,” and press ENTER.

### 15 Check the settings, and select “Finish,” then press ENTER.

The message “Settings are complete.” appears.

If an error message appears in the network diagnostic results, check the message and set the network settings again.

2 Press  $\rightarrow$ , and enter the next character. If you make a mistake, follow the next steps.

① Move the highlight to the entry field using  $\uparrow/\downarrow$ .

The colour of the cursor changes to yellow.

② Move the cursor to the left side of the character you want to delete using  $\leftarrow$ .

Example: when you want to delete “H” (“SSID Entry” display)

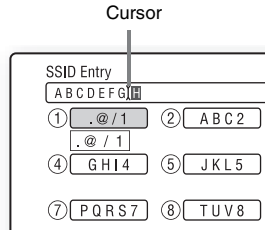

③ Select “Clear,” and press ENTER.



Make sure the security key is correctly entered before you proceed to step 3. Once you press the blue button (“Finish”) in step 3 and go to the next step, you may not be able to check the characters on the screen.

3 Press the blue button (“Finish”) to finish. When you input SSID, press  $\rightarrow$  to go to the next screen.

When you input “Proxy Server,” press RETURN to exit.

#### ◆ Available buttons

Buttons	Details
Red button (Letter Type)	Switches the keyboard between alphabet and numbers.
Green button (A/a)	Switches the keyboard between upper case and lower case.
Yellow button (Symbol)	Displays the keyboard for symbols.
Blue button (Finish)	The input is entered, and the player returns to the previous display.

#### To enter characters

Use the following procedure to enter SSID, the WEP/WPA key, or “Proxy Server.”

Entry field

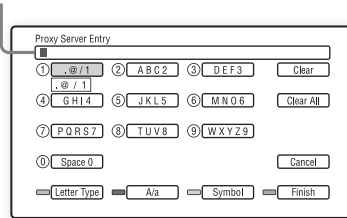

1 Press a number button repeatedly to select a character.

Example:

Press the number 3 button once to enter “D.”

Press the number 3 button three times to enter “F.”

Buttons	Details
CLEAR (Clear/Clear All)	Erases the selected character. To erase all displayed characters, press and hold CLEAR for 2 seconds or more.
RETURN (Cancel)	Returns to the previous display, cancelling the input.
←/↑/↓/→, ENTER	<ul style="list-style-type: none"> <li>Select an input function using ←/↑/↓/→, and press ENTER.</li> <li>Enter characters as follows: ①Select a character selection panel using ←/↑/↓/→, and press ENTER. ②Select a character using ←/→, and press ENTER.</li> </ul>

## Network Connection Diagnostics

You can run the network diagnostic.

**1** Select “Network Connection Diagnostics” in “Network Settings,” and press ENTER.

**2** Select “Start,” and press ENTER.

The network diagnostic starts. Results are displayed after the player finishes running the network diagnostic. If an error message appears, follow the on-screen instructions and perform “Network Connection Diagnostics” again.

**3** Select “Finish,” and press ENTER.

## Connection Server Settings

**1** Connect a DLNA certified device to the network set in “Step 4: Connecting to the Network” on page 27, and set up the DLNA certified device as a home server.

For details, refer to the instruction manual supplied with the DLNA certified device.



When a firewall is set for the DLNA certified device, disable the function. For details, refer to the instruction manual supplied with the DLNA certified device.

**2** Press HOME.

**3** Select (Setup) using ←/→.

**4** Select “Connection Server Settings” in “Network Settings,” and press ENTER.

The connected server list appears.

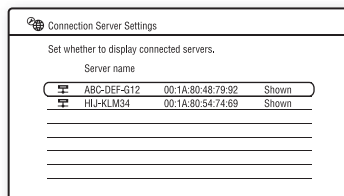

If no server appears in the server list, press OPTIONS to select “Update Server List,” and press ENTER.

**5** Press OPTIONS to select “Network Diagnostic,” and press ENTER.

**6** Select “Start,” and press ENTER.

The network diagnostic starts. Results are displayed after the player finishes running the network diagnostic.

- To display detailed results for a server, select a server using ↑/↓, and press ENTER. To go back to the results display, select “Close,” and press ENTER.

**7** Press RETURN to return to the server list.

**8** Press RETURN to exit.

## To display/hide a server

- 1 While the connected server list is displayed, select a server using **↑/↓**, and press ENTER.
- 2 Select “Shown” or “Hidden” using **↑/↓**, and press ENTER.  
When you select “Hidden,” the server will not be displayed in the photo category.



You can hide a server in the photo category as well. Select the server using **↑/↓**, and press OPTIONS to select “Hidden,” then press ENTER.

## To delete a server from the connected server list

- 1 While the connected server list is displayed, select a server using **↑/↓**, and press OPTIONS.
- 2 Select “Erase,” and press ENTER.  
To delete all the servers, select “Erase All.”  
The display asks for confirmation.
- 3 Select “OK,” and press ENTER.  
The selected server is erased.

## Easy Setup

Re-runs the Easy Setup to make the basic settings.

- 1 Select “Easy Setup,” and press ENTER.
- 2 Select “Start” using **←/→**, and press ENTER.
- 3 Follow the instructions for “Step 7: Easy Setup” (page 31) from step 4.

---

## **Resetting**

You can reset the player settings to the factory default by selecting the group of settings. All the settings within the group will be reset.

**1** Select “Resetting,” and press **ENTER**.

**2** Select “Reset to Factory Default Settings,” and press **ENTER**.

**3** Select the settings you want to reset to default, and press **ENTER**.

The display asks for confirmation.

You can reset the following settings:

- Video Settings
- Audio Settings
- BD/DVD Viewing Settings
- Photo Settings
- System Settings
- Network Settings
- All Settings

**4** Select “Start” using **←/→**, and press **ENTER**.

---



When “All Settings” is selected in step 3,

- all settings within  (Setup) are reset.
- “Video Settings” and “Audio Settings” that can be adjusted by pressing **OPTIONS** during playback (page 41) are not reset.

## Additional Information

# Troubleshooting

If you experience any of the following difficulties while using the player, use this troubleshooting guide to help remedy the problem before requesting repairs. Should any problem persist, consult your nearest Sony dealer.

## Power

### The power does not turn on.

- ➔ Check that the mains lead is connected securely.
- ➔ It takes a short while before the player turns on.

### The message “A new software version has been found on the network. Perform update under “Network Update.”” appears on the screen when turning the player on.

- ➔ See “Network Update” (page 49) to update the player to a newer software version.

## Disc

### The disc does not play.

- ➔ The disc is dirty.
- ➔ The disc is upside down. Insert the disc with the playback side facing down.
- ➔ The disc is skewed.
- ➔ You are attempting to play a disc with a format that cannot be played back by this player (page 75).
- ➔ The region code on the BD or DVD does not match the player.
- ➔ The player cannot play a recorded disc that is not correctly finalised (page 75).

## Picture

See also “Connecting to an HDMI jack” (page 17) when connecting equipment using the HDMI cable.

### There is no picture/picture noise appears.

- ➔ Check that all the connecting cables are securely connected.

- ➔ Check whether the connecting cables are damaged.
- ➔ Check the connection to your TV (page 16) and switch the input selector on your TV so that the signal from the player appears on the TV screen.
- ➔ When playing a double-layer BD/DVD, the video and audio may be momentarily interrupted at the point where the layers switch.

---

**No picture appears when the video output resolution selected in “Output Video Format” is incorrect.**

- ➔ Press ■ on the player for more than 10 seconds to reset the video output resolution to the lowest resolution.

---

**The picture does not fill the screen, even though the aspect ratio is set in “DVD Aspect Ratio” under “Video Settings.”**

- ➔ The aspect ratio of the disc is fixed on your DVD (page 51).

---

**Video signals are not output from the jacks, other than from the HDMI OUT jack, when connecting the HDMI OUT jack and other video output jacks at the same time.**

- ➔ Set “Output Video Format” to “Component Video” in the “Video Settings” setup (page 51).

---

**The dark area of the picture is too dark/the bright area is too bright or unnatural.**

- ➔ Set “Picture Quality Mode” to “Standard” (default) (see “Adjusting pictures and sound for videos” on page 41).

---

**The picture is not output correctly.**

- ➔ Check the “Output Video Format” settings in the “Video Settings” setup (page 51).

---

**No BD-ROM picture appears.**

- ➔ Check the “BD-ROM 1080/24p Output” setting in the “Video Settings” setup (page 52).

## Sound

See also “Connecting to an HDMI jack” (page 22) when connecting equipment using the HDMI cable.

---

**There is no sound.**

- ➔ Check that all the connecting cables are securely connected.
- ➔ Check whether the connecting cables are damaged.
- ➔ Check the connection to your AV amplifier (receiver) (page 21) and switch the input selector on your AV amplifier (receiver) so that the audio signals of the player are output from your AV amplifier (receiver).
- ➔ The player is in scan mode.
- ➔ If the audio signal does not come through the DIGITAL OUT (OPTICAL/COAXIAL)/HDMI OUT jack, check the audio settings (page 54).

---

**The sound is not output correctly.**

- ➔ Check the “Audio Output Priority” setting in the “Audio Settings” setup (page 54).
- ➔ Check the speaker settings (page 54).

---

**The sound volume is low.**

- ➔ The sound volume is low on some BDs or DVDs.
- ➔ Try setting “Audio DRC” to “TV Mode” in the “Audio Settings” setup (page 58).
- ➔ Set “Audio ATT” to “Off” in the “Audio Settings” setup (page 57).

---

**The HD Audio (Dolby Digital Plus, Dolby TrueHD, DTS-HD High Resolution Audio, and DTS-HD Master Audio) is not output by bitstream.**

- ➔ Set “BD Audio Setting” to “Direct” in the “Audio Settings” setup (page 57).
- ➔ Check that the connected AV amplifier (receiver) is compatible with each HD Audio format.

---

**The interactive audio is not output.**

- ➔ Set “BD Audio Setting” to “Mix” in the “Audio Settings” setup (page 57).

## HDMI

### There is no picture or no sound when connected to the HDMI OUT jack.

- ➔ Try the following: ① Turn the player off and on again. ② Turn the connected equipment off and on again. ③ Disconnect and then reconnect the HDMI cable.
- ➔ If the player is connected to a TV through an AV amplifier (receiver), try connecting the HDMI cable directly to the TV. If the problem is fixed, refer to the instruction manual supplied with the AV amplifier (receiver).

### There is no picture or picture noise appears when connected to the HDMI OUT jack.

- ➔ The HDMI OUT jack is connected to a DVI device that does not support copyright protection technology.
- ➔ If the HDMI OUT jack is used for video output, changing the video output resolution may solve the problem (page 51).

### No sound is output from the HDMI OUT jack.

- ➔ The HDMI OUT jack is connected to a DVI device (DVI jacks do not accept audio signals).

### The sound is not output correctly when connected to the HDMI OUT jack.

- ➔ The device connected to the HDMI OUT jack does not support the audio format of the player. Check the audio settings (page 54).

### The display language on the screen switches automatically when connected to the HDMI OUT jack.

- ➔ When “Control for HDMI” is set to “On” (page 61), the display language on the screen automatically switches according to the language setting of the connected TV (if you change the setting on your TV, etc.).

### The “Control for HDMI” function does not work (BRAVIA Sync).

- ➔ Check that the mains lead of the connected component is securely connected.
- ➔ If the HDMI indicator does not appear in the front panel display, check the HDMI connection (page 17, 22).
- ➔ Check that “Control for HDMI” is set to “On” (page 61).
- ➔ Make sure that the connected component is compatible with the “Control for HDMI” function. For details, refer to the instruction manual supplied with the component.
- ➔ Check the connected component’s setting for the “Control for HDMI” function. For details, refer to the instruction manual supplied with the component.
- ➔ If you change the HDMI connection, turn the player off and on again.
- ➔ If power failure occurs, set “Control for HDMI” to “Off,” then set “Control for HDMI” to “On” (page 61).
- ➔ For details on the “Control for HDMI” function, see “About the BRAVIA Sync features (for HDMI connections only)” (page 18).
- ➔ If you connect the player to a TV through an AV amplifier (receiver) that is not compatible with the “Control for HDMI” function, you may be unable to control the TV from the player.
- ➔ When you connect the player to a TV through an AV amplifier (receiver), if you change the HDMI connection, disconnect and reconnect the mains lead, or a power failure occurs, try the following: ① Switch the input selector of the AV amplifier (receiver) so that the picture from the player appears on the TV screen. ② Set “Control for HDMI” to “Off,” then set “Control for HDMI” to “On” (page 61). Refer to the instruction manual supplied with the AV amplifier (receiver).

## External memory (local storage)

### The external memory is not recognised.

- ➔ Try the following: ①Turn the player off. ②(USM1GH only) Align the ▼ mark of the EXT slot with the ▼ mark on the external memory, and insert the external memory. ③Turn the player on. ④Check that the EXT indicator lights up in the front panel display.

### Bonus contents or other data that are contained in a BD-ROM cannot be played.

- ➔ Try the following: ①Remove the disc. ②Turn the player off. ③Remove and re-insert the external memory (page 26). ④Turn the player on. ⑤Check that the EXT indicator lights up in the front panel display. ⑥Insert the BD-ROM with BONUSVIEW/BD-LIVE.

### A message indicating that the local storage does not have enough space appears on the screen.

- ➔ Delete unnecessary data in the external memory (page 39).

## Operation

### The remote does not function.

- ➔ The batteries in the remote are weak (page 29).
- ➔ The distance between the remote and the player is too far.
- ➔ The remote is not pointed at the remote sensor on the player.

### The player does not detect a USB device connected to the player.

- ➔ Make sure that the USB device is securely connected to the USB jack on the front panel (page 46).
- ➔ Check if the USB device or a cable is damaged.
- ➔ Check if the USB device is on.
- ➔ The USB device is connected via a USB hub. Connect the USB device directly to the player.

### The file name is not correctly displayed.

- ➔ The player can only display ISO 8859-1-compliant character formats. Other character formats may be displayed differently.
- ➔ Depending on the writing software used, the input characters may be displayed differently.

### The disc does not start playing from the beginning.

- ➔ Resume Play is on (page 37).

### Some functions such as Stop or Search cannot be performed.

- ➔ Depending on the disc, you may not be able to do some of the operations above. Refer to the instruction manual supplied with the disc.

### The language for the soundtrack/subtitle or angles cannot be changed.



- ➔ Try using the BD's or DVD's menu instead of the direct selection button on the remote (page 38).
- ➔ Multi-lingual tracks/subtitles or multi-angles are not recorded on the BD or DVD being played.
- ➔ The BD or DVD prohibits the changing of the language for the soundtrack/subtitle or angles.

### The disc tray does not open and "LOCKED" or "TLK ON" appears in the front panel display.

- ➔ When "LOCKED" appears, the player is locked. To cancel the Child Lock, hold down ► on the player until "UNLOCK" appears in the front panel display (page 12).
- ➔ When "TLK ON" appears, contact your Sony dealer or local authorised Sony service facility.



### The disc tray does not open and you cannot remove the disc even after you press .

- ➔ Try the following: ① Turn the player off, and disconnect the mains lead.
- ② Reconnect the mains lead while pressing down  on the player.
- ③ Keep pressing down  on the player until the tray opens.
- ④ Remove the disc.
- ⑤ When “WAIT” appears in the front panel display, hold down  on the player for more than 10 seconds until the player turns on again.

### The player does not respond to any button.

- ➔ Moisture has condensed inside the player (page 3).
  - ➔ Hold down  on the player for more than 10 seconds until the indicators in the front panel display turn off.
- If the player still does not respond to any button, disconnect then reconnect the mains lead.

## Wireless LAN

### You cannot connect your PC to the Internet after you set the “Setting wireless LAN (Automatic registration (WPS))” settings.

- ➔ The wireless settings of the wireless LAN router (access point) may change automatically if you use the Wi-Fi Protected Setup function before adjusting the settings of the wireless LAN router (access point). In this case, check the wireless settings of the wireless LAN router (access point), and change the wireless settings of your PC accordingly. For details, refer to the instruction manual supplied with the wireless LAN router (access point).

### You cannot connect the player to the wireless LAN router (access point).

- ➔ Check if the wireless LAN router (access point) is on.

- ➔ Depending on the surrounding environment such as the wall material, radio wave receiving condition, or obstacles between the player and the wireless LAN router (access point), the communication distance may be shortened. Move the player and the wireless LAN router (access point) closer to each other.

- ➔ Devices that use a 2.4 GHz frequency band such as a microwave, Bluetooth, or digital cordless device may interrupt the communication. Move the player away from such devices, or turn off such devices.

### The wireless LAN router (access point) is not displayed on “Access point scan” list.

- ➔ The wireless LAN router (access point) is not displayed if you set the SSID to hide with the wireless LAN router (access point). Check and reset the SSID of the wireless LAN router (access point) manually (page 63).

## Self-Diagnosis Function

When the self-diagnosis function is activated to prevent the player from malfunctioning, an error code appears in the front panel display, or just  appears without any messages on the entire screen.

In these cases, check the following.















### When an error code appears in the front panel display

Error code	Corrective action
Exxxx SYS ERR VUP NG	Contact your nearest Sony dealer or local authorised Sony service facility and give the error code.
FAN ERR	<ul style="list-style-type: none"> <li>• Check that the ventilation holes on the rear of the player are not blocked.</li> <li>• Place the player in a location with adequate ventilation to prevent heat build-up in the player.</li> </ul>

### When just appears without any messages on the entire screen

Contact your nearest Sony dealer or local authorised Sony service facility.

# Playable Discs

Type	Disc Logo	Icon used in this manual	Characteristics
Blu-ray Disc			BD-ROMs and BD-REs/BD-Rs in BDMV and BDAV mode, including 8 cm discs (single layer) and DL discs
			BD-REs/BD-Rs containing MP3 audio tracks* or JPEG image files
DVD VIDEO			Discs such as movies that can be purchased or rented
DVD	   DVD + ReWritable		DVD+RWs/DVD+Rs in +VR mode or DVD-RWs/DVD-Rs in video and VR mode, including 8 cm discs (single layer) and DVD+R DL/DVD-R DL discs
DATA DVD	 DVD + R  DVD + R DL		DVD-ROMs and DVD+RWs/DVD+Rs/DVD-RWs/DVD-Rs containing MP3 audio tracks* or JPEG image files
CD			Music CDs or CD-Rs/CD-RWs in music CD format
DATA CD	—		CD-ROMs and CD-Rs/CD-RWs containing MP3 audio tracks* or JPEG image files

\* MP3 (MPEG-1 Audio Layer 3) is a standard format defined by ISO (International Organization for Standardization)/IEC (International Electrotechnical Commission) MPEG which compresses audio data. MPEG Layer-3 audio coding technology and patents licensed from Fraunhofer IIS and Thomson.

## Notes about BD-ROM compatibility

Since the Blu-ray Disc specifications are new and evolving, some discs may not be playable depending on the disc type and the version. The audio output differs depending on the source, connected output jack, and selected audio settings. For details, see page 77.

## Discs that cannot be played

- BDs with cartridge
- DVD-RAMs
- HD DVDs
- DivX discs
- DVD Audio discs
- PHOTO CDs
- Data part of CD-Extras
- VCDs/Super VCDs
- HD layer on Super Audio CDs
- Audio material side on DualDiscs
- BD-ROMs/DVD VIDEOS with a different region code (page 75).

## Note on playback operations of BDs/DVDs

Some playback operations of BDs/DVDs may be intentionally set by software producers. Since this player plays BDs/DVDs according to the disc contents the software producers designed, some playback features may not be available. Refer to the instruction manual supplied with the BDs/DVDs.

## Region code (BD-ROM/DVD VIDEO only)

Your player has a region code printed on the rear of the unit and will only play BD-ROMs/DVD VIDEOS (playback only) labelled with identical region codes. This system is used to protect copyrights.

DVD VIDEOS labelled  will also play on this player.

Depending on the BD-ROM/DVD VIDEO, no region code may be indicated even though playing the BD-ROM/DVD VIDEO is prohibited by area restrictions.

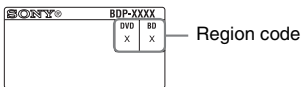

## Notes about BD-REs/BD-Rs, DVD+RWs/DVD+Rs, DVD-RWs/DVD-Rs, or CD-Rs/CD-RWs

Some BD-REs/BD-Rs, DVD+RWs/DVD+Rs, DVD-RWs/DVD-Rs, or CD-Rs/CD-RWs cannot be played on this player due to the recording quality or physical condition of the disc, or the characteristics of the recording device and authoring software. The BD-Rs recorded on a PC cannot be played if postscripts are recordable. A CD or DVD disc will not play if it has not been correctly finalised. For more information, refer to the instruction manual supplied with the recording device. Note that some playback functions may not work with some DVD+RWs/DVD+Rs, even if they have been correctly finalised. In this case, view the disc using normal playback.

## Music discs encoded with copyright protection technologies

This product is designed to play back discs that conform to the Compact Disc (CD) standard. Various music discs encoded with copyright protection technologies are being marketed by some record companies. Please be aware that among those discs, there are some that do not conform to the CD standard and may not be playable by this product.

## Note on DualDiscs

A DualDisc is a two sided disc product which mates DVD recorded material on one side with digital audio material on the other side.

However, since the audio material side does not conform to the Compact Disc (CD) standard, playback on this product is not guaranteed.

## Note about double-layer BDs/DVDs

The playback pictures and sound may be momentarily interrupted when the layers switch.

## Note about 8 cm BD-REs/8 cm BD-Rs

Some 8 cm BD-REs/8 cm BD-Rs cannot be played on this player.

## Note about BD-REs/BD-Rs

This player supports Ver. 2.1 BD-RE and Ver. 1.1, 1.2 and 1.3 BD-R including organic pigment type BD-R (LTH type).

## Note about DTS 5.1 MUSIC DISCS

This player can play DTS 5.1 MUSIC DISCS.

## About playback of discs recorded in AVCHD format

This player can play AVCHD format discs.



### ◆ What is the AVCHD format?

The AVCHD format is a high-definition digital video camera format used to record SD (standard definition) or HD (high definition) signals of either the 1080i specification\*<sup>1</sup> or the 720p specification\*<sup>2</sup> on DVDs, using efficient data compression coding technology. The MPEG-4 AVC/H.264 format is adopted to compress video data, and the Dolby Digital or Linear PCM system is used to compress audio data. The MPEG-4 AVC/H.264 format is capable of compressing images at higher efficiency than that of the conventional image compressing format. The MPEG-4 AVC/H.264 format enables a high definition (HD) video signal shot on a digital video camera recorder to be recorded on DVD discs, in the same way as it would be for a standard definition (SD) television signal.

\*<sup>1</sup> A high-definition specification which utilizes 1080 effective scanning lines and the interlace system.

\*<sup>2</sup> A high-definition specification which utilizes 720 effective scanning lines and the progressive system.



- Some AVCHD format discs may not play, depending on the recording condition.
- The AVCHD format disc will not play if it has not been correctly finalised.

## Video Output Resolution

Output resolution differs depending on the “Output Video Format” setting in the “Video Settings” setup (page 51).

Resolution setting	When “Output Video Format” is set to “HDMI”			When “Output Video Format” is set to “Component Video”		
	LINE OUT VIDEO/S VIDEO jack	COMPONENT VIDEO jacks	HDMI OUT jack	LINE OUT VIDEO/S VIDEO jack	COMPONENT VIDEO jacks	HDMI OUT jack
480i/576i	480i/576i	480i/576i	480i/576i	480i/576i	480i/576i	480i/576i
480p/576p	480i/576i	480i/576i	480p/576p	480i/576i	480p/576p	480p/576p
720p	480i/576i	480i/576i	720p	480i/576i	720p*	720p*
1080i	480i/576i	480i/576i	1080i	480i/576i	1080i*	1080i*
1080p	no picture	no picture	1080p	unselectable	unselectable	unselectable

\* Protected contents on DVDs are output at 480p/576p resolution. Protected contents on BDs are output at 576p resolution.

### ◆ When “Output Video Format” is set to “Video or S Video”

480i/576i video signals are output from the LINE OUT VIDEO/S VIDEO or COMPONENT VIDEO jack, and 480p/576p video signals are output from the HDMI OUT jack.

# Audio Output Signals and Player Settings

The audio output signals differ, depending on the source, output jack, and the AV amplifier (receiver) you use. To enjoy the sound you want, check the support audio format of the AV amplifier (receiver), the connection to the AV amplifier (receiver), and the “Audio Settings” setup pattern according to the tables below.

To enjoy		Connections and settings					
Disc/source	Audio output signal	AV amplifier (receiver) support audio format	Player audio jack <sup>*1</sup>	“Audio Settings” setup pattern			
BD	HD Audio <sup>*3</sup>	HD Audio <sup>*2</sup>	HDMI OUT	Ⓐ			
		Up to 7.1ch LPCM <sup>*3</sup>				Multi-channel LPCM	
		Dolby Digital/DTS				Dolby Digital/DTS	
		Dolby Digital/DTS <sup>*4</sup>	Dolby Digital/DTS	DIGITAL OUT	Ⓒ		
	Dolby Digital/DTS	7.1ch	—	MULTI CHANNEL OUTPUT	Ⓓ		
			Dolby Digital/DTS	Dolby Digital/DTS	HDMI OUT	Ⓐ	
		Dolby Digital/DTS	Dolby Digital/DTS	DIGITAL OUT	Ⓒ		
		Up to 7.1ch LPCM	Multi-channel LPCM	HDMI OUT	Ⓐ		
			5.1ch	—	MULTI CHANNEL OUTPUT	Ⓓ	
		7.1ch LPCM/5.1ch LPCM	7.1ch LPCM/5.1ch LPCM	Multi-channel LPCM	HDMI OUT	Ⓑ	
			2ch LPCM	2ch LPCM	DIGITAL OUT	Ⓒ	
			7.1ch/5.1ch	—	MULTI CHANNEL OUTPUT	Ⓓ	
		DVD	Dolby Digital/DTS	Dolby Digital/DTS	HDMI OUT	Ⓑ	
Dolby Digital/DTS	DIGITAL OUT			Ⓒ			
5.1ch	—		MULTI CHANNEL OUTPUT	Ⓓ			

“Audio Settings” setup table

Setup pattern	Audio Output Priority <sup>*5</sup> (page 54)	Audio (HDMI) <sup>*6</sup> (page 57)	BD Audio Setting (page 57)	DTS <sup>*6</sup> (page 57)	Dolby Digital <sup>*6</sup> (page 57)
ⒶⒷ	HDMI	Auto	Ⓐ Direct Ⓑ Mix or Direct	—	—
Ⓒ	Coaxial/Optical	—	—	DTS	Dolby Digital
Ⓓ	Multi Channel Analogue	—	—	—	—

<sup>\*1</sup> When connecting to the LINE OUT (R-AUDIO-L) jacks, 2-channel signals are output.

<sup>\*2</sup> HD Audio includes Dolby TrueHD, Dolby Digital Plus, DTS-HD Master Audio, and DTS-HD High Resolution Audio formats.

<sup>\*3</sup> For Dolby TrueHD and DTS-HD Master Audio, set “HDMI Resolution” of “Output Video Format” to other than “480i/576i” or “480p/576p” in the “Video Settings” setup (page 51).

<sup>\*4</sup> The 2-channel or less-channel primary/secondary audio signals are output as 2-channel LPCM signals.

\*5 The 2-channel LPCM signals are output from output jacks other than priority jacks.

- \*6 The 2-channel LPCM signals are output in the following cases:
- when “Audio (HDMI)” is set to “2ch PCM” in the “Audio Settings” setup.
  - when “Dolby Digital”/“DTS” is set to “Downmix PCM” in the “Audio Settings” setup.
  - when you play a DVD that contains MPEG Audio.

---

## About Wireless LAN Security

Since communication via the wireless LAN function is established by radio waves, the wireless signal may be susceptible to interception. To protect wireless communication, this player supports various security functions. Be sure to correctly configure the security settings in accordance with your network environment.

### ◆ No Security

Although you can easily make settings, anyone can intercept wireless communication or intrude into your wireless network, even without any sophisticated tools. Keep in mind that there is a risk of unauthorized access or interception of data.

### ◆ WEP

WEP applies security to communications to prevent outsiders from intercepting communications or intruding into your wireless network. WEP is a legacy security technology that enables older devices, which do not support TKIP/AES, to be connected.

### ◆ WPA-PSK (TKIP)

TKIP is a security technology developed to correct for the deficiencies of WEP. TKIP assures a higher security level than WEP.

### ◆ WPA-PSK (AES), WPA2-PSK (AES)

AES is a security technology that uses an advanced security method that is distinct from WEP and TKIP.

AES assures a higher security level than WEP or TKIP.

# Specifications

## System

**Laser:** Semiconductor laser

## Inputs and outputs

### (Jack name:

Jack type/Output level/Load impedance)

### LINE OUT R-AUDIO-L:

Phono jack/2 V<sub>rms</sub>/10 kilohms

### DIGITAL OUT (OPTICAL):

Optical output jack/-18 dBm  
(wave length 660 nm)

### DIGITAL OUT (COAXIAL):

Phono jack/0.5 V<sub>p-p</sub>/75 ohms

### MULTI CHANNEL OUTPUT:

Phono jack/2 V<sub>rms</sub>/10 kilohms

### PHONES:

Stereo phone jack/10 mW/(32 ohms)

### HDMI OUT:

HDMI 19-pin standard connector

### COMPONENT VIDEO OUT

#### (Y, P<sub>B</sub>/C<sub>B</sub>, P<sub>R</sub>/C<sub>R</sub>):

Phono jack/Y: 1.0 V<sub>p-p</sub>/  
P<sub>B</sub>/C<sub>B</sub>, P<sub>R</sub>/C<sub>R</sub>: 0.7 V<sub>p-p</sub>/75 ohms

### LINE OUT VIDEO:

Phono jack/1.0 V<sub>p-p</sub>/75 ohms

### LINE OUT S VIDEO:

4-pin mini DIN/  
Y: 1.0 V<sub>p-p</sub>, C: 0.3 V<sub>p-p</sub>/75 ohms

### LAN (100):

100BASE-TX Terminal

### EXT:

External memory slot (For connecting the external memory)  
DC output: 5 V 500 mA Max

### USB:

USB jack Type A (For connecting digital still camera and USB memory)

## Wireless

### Wireless LAN standard:

IEEE802.11a/b/g  
IEEE802.11n draft 2.0

### Frequency range:

European models:  
2.4 GHz band: Channels 1-13  
5 GHz band: Channels 36-64, 100-140  
Australian/New Zealand models:  
Australia only  
2.4 GHz band: Channels 1-13  
5 GHz band: Channels 36-64, 100-116,  
132-140, 149-165  
New Zealand only  
2.4 GHz band: Channels 1-13  
5 GHz band: Channels 36-64, 100-140,  
149-165

## Modulation:

DS-SS Modem and OFDM Modem

## General

### Power requirements:

220-240 V AC, 50/60 Hz

### Power consumption:

32 W

### Dimensions (approx.):

430 mm × 246 mm × 70 mm  
(width/depth/height) incl. projecting parts

### Mass (approx.):

3.0 kg

### Operating temperature:

5 °C to 35 °C

### Operating humidity:

25 % to 80 %

## Supplied accessories

See page 15.

Specifications and design are subject to change without notice.

# Language Code List

For details, see page 59.

The language spellings conform to the ISO 639: 1988 (E/F) standard.

Code	Language	Code	Language	Code	Language	Code	Language
1027	Afar	1186	Scots Gaelic	1349	Macedonian	1511	Albanian
1028	Abkhazian	1194	Galician	1350	Malayalam	1512	Serbian
1032	Afrikaans	1196	Guarani	1352	Mongolian	1513	Siswati; Swati
1039	Amharic	1203	Gujarati	1353	Moldavian	1514	Sesotho; Sotho southern
1044	Arabic	1209	Hausa	1356	Marathi	1515	Sundanese
1045	Assamese	1217	Hindi	1357	Malay	1516	Swedish
1051	Aymara	1226	Croatian	1358	Maltese; Maltese	1517	Swahili
1052	Azerbaijani	1229	Hungarian	1363	Burmese	1521	Tamil
1053	Bashkir	1233	Armenian	1365	Nauru	1525	Telugu
1057	Byelorussian	1235	Interlingua	1369	Nepali	1527	Tajik
1059	Bulgarian	1239	Interlingue	1376	Dutch	1528	Thai
1060	Bihari	1245	Nupiak	1379	Norwegian	1529	Tigrinya
1061	Bislama	1248	Indonesian	1393	Occitan	1531	Turkmen
1066	Bengali	1253	Icelandic	1403	Oromo	1532	Tagalog
1067	Tibetan	1254	Italian	1408	Oriya	1534	Setswana; Tswana
1070	Breton	1257	Hebrew	1417	Punjabi; Panjabi	1535	Tonga; Tonga islands
1079	Catalan	1261	Japanese	1428	Polish	1538	Turkish
1093	Corsican	1269	Yiddish	1435	Pashto; Pushto	1539	Tsonga
1097	Czech	1283	Javanese	1436	Portuguese	1540	Tatar
1103	Welsh	1287	Georgian	1463	Quechua	1543	Twi
1105	Danish	1297	Kazakh	1481	Rhaeto-Romance	1557	Ukrainian
1109	German	1298	Greenlandic;	1482	Kirundi; Rundi	1564	Urdu
1130	Bhutani; Dzongkha		Kalaallisut	1483	Romanian	1572	Uzbek
1142	Greek	1299	Cambodian; Khmer	1489	Russian	1581	Vietnamese
1144	English	1300	Kannada	1491	Kinyarwanda	1587	Volapük
1145	Esperanto	1301	Korean	1495	Sanskrit	1613	Wolof
1149	Spanish	1305	Kashmiri	1498	Sindhi	1632	Xhosa
1150	Estonian	1307	Kurdish	1501	Sango; Sango	1665	Yoruba
1151	Basque	1311	Kirghiz	1502	Serbo-Croatian	1684	Chinese
1157	Persian	1313	Latin	1503	Sinhalese;	1697	Zulu
1165	Finnish	1326	Lingala		Sinhalese	1703	not specified
1166	Fiji	1327	Laothian; Lao	1505	Slovak		
1171	Faroese	1332	Lithuanian	1506	Slovenian		
1174	French	1334	Latvian	1507	Samoan		
1181	Frisian	1345	Malagasy	1508	Shona		
1183	Irish	1347	Maori	1509	Somali		

# Parental Control/Area Code

For details, see page 60.

## Number, Area (Code)

2044, Argentina (ar)	2200, Greece (gr)	2379, Norway (no)
2047, Australia (au)	2219, Hong Kong (hk)	2427, Pakistan (pk)
2046, Austria (at)	2248, India (in)	2424, Philippines (ph)
2057, Belgium (be)	2238, Indonesia (id)	2428, Poland (pl)
2070, Brazil (br)	2239, Ireland (ie)	2436, Portugal (pt)
2079, Canada (ca)	2254, Italy (it)	2489, Russia (ru)
2090, Chile (cl)	2276, Japan (jp)	2501, Singapore (sg)
2092, China (cn)	2304, Korea (kr)	2149, Spain (es)
2093, Colombia (co)	2333, Luxembourg (lu)	2499, Sweden (se)
2115, Denmark (dk)	2363, Malaysia (my)	2086, Switzerland (ch)
2165, Finland (fi)	2362, Mexico (mx)	2543, Taiwan (tw)
2174, France (fr)	2376, Netherlands (nl)	2528, Thailand (th)
2109, Germany (de)	2390, New Zealand (nz)	2184, United Kingdom (gb)



# Terms and Conditions of Use and End User License Agreement

The Sony Blu-ray Disc player ("Product") and associated software ("Software") are provided and maintained by Sony Corporation and its affiliates ("Sony"). Sony also provides and maintains associated service (the "Service"), including any subsite accessible through the Service's Internet homepage (the "Site"). The Software includes software embedded in the Product; stored on any media, bundled with the Product or otherwise provided by Sony; downloaded from the Site or otherwise made accessible or provided by Sony; any such media and any printed or "on-line" or electronic documentation associated with the Product and all updates and upgrades thereto.

WHEN YOU ACCESS, BROWSE, OR USE THE SERVICE, PRODUCT, SOFTWARE, AND/OR SITE, YOU ACCEPT, WITHOUT LIMITATION OR QUALIFICATION, THE TERMS AND CONDITIONS SET FORTH HEREIN, SONY'S PRIVACY POLICY POSTED ON THE SITE, AND ANY ADDITIONAL TERMS AND CONDITIONS OF USE SET FORTH IN ANY PORTION OF THE SERVICE AND SITE (COLLECTIVELY THE "AGREEMENT"). IF YOU DO NOT AGREE WITH THE TERMS AND CONDITIONS OF THIS AGREEMENT, SONY DOES NOT GRANT THE LIMITED RIGHTS HEREIN, AND PLEASE DO NOT USE THE SERVICE, PRODUCT, SOFTWARE, AND/OR SITE.

## 1. Ownership

The Software and all materials on the Service and/or Site, including but not limited to images, software and text (the "Content") are protected by copyright under copyright law and international conventions. You cannot use the Software, Service, Product, Content, and Site except as specified herein. There may be proprietary logos, service marks, and trademarks found on this Service or Site. By making them available on the Service and/or Site, Sony is not granting you any license to utilize those proprietary logos, service marks, or trademarks. Any unauthorized use of the Service, Site, Content or Software may violate copyright laws, trademark laws, the laws of privacy and publicity, and civil and criminal statutes. All title and copyright in and to the Software or materials on the Service/Site and any copies of the Software, are owned by Sony, its licensors, or suppliers. All rights not specifically granted under this Agreement are reserved by Sony, its licensors, and suppliers.

## 2. Your Rights & Limited License

The Service, Site, Software, Content, and Product are only for your personal use. You are responsible for all your activities hereunder, including all legal liability incurred from your use of the Service or others who use the Service via your Product. You may use the Service, Site, Software, Content and Product for lawful purposes only. You may not distribute, exchange, modify, sell, or transmit anything you may copy from the Service or Site, including but not limited to any text, images, audio, and video, for any business, commercial, or public purpose. As long as you comply with the terms of this Agreement, Sony grants you a non-exclusive, non-transferable, limited right to enter, display, and use the Service, Site, and Software as set forth in this Agreement. You agree not to interrupt/disrupt or attempt to interrupt/disrupt the operation of this Service, Site or Software in any way.

## 3. Automatic Update

The Software contains a functionality by which it is updated automatically when the Product is connected to a server belonging to Sony or to a third party designated by Sony. When you specify your intention not to use this automatic update functionality, or when the setting asking whether you wish to update automatically is activated and you decline to execute updates, it is assumed that you agree that the security functionality improvements, error corrections, other functional updates or any other changes offered by Sony through such updates would not be made to the Software and that your current and further use of the Software may be affected thereby.

When the automatic update functionality described in the previous paragraph is activated, it is assumed that you agree (a) that the Software will be automatically updated as necessary to improve security functionality, to correct errors, to improve update functionality, or for other purposes, and (b) that this updating of the Software may be accompanied by the augmenting, modifying, or removing of functionality of the Software.

## 4. Additional Terms Governing Product Software

You may use the Software solely in conjunction with the Product that accompanied the Software. The Software is licensed, not sold. In addition to the terms set forth in other portions of this Agreement, the Software is subject to the following:

**Use of Software.** You may use the Software in conjunction with the Product for personal use.

**Limitation on Reverse Engineering, Decompilation and Disassembly.** You may not modify, reverse engineer,

decompile, or disassemble the Software in whole or in part.

**Separation of Components.** The Software is licensed as a single product. Its component parts may not be separated for use on more than one device unless expressly authorized by Sony.

**Data Files.** The Software may create data files automatically for use with the Software. Any such data files will be deemed as part of the Software.

**Rental.** You may not rent or lease the Software.

**Software Transfer.** You may permanently transfer all of your rights under this Agreement only as part of a sale or transfer of Software accompanying the sale or transfer of your Product, provided you retain no copies, transfer all of the Software (including all copies, component parts, the media and printed materials, all versions and any upgrades of the Software and this Agreement), and the recipient agrees to the terms of this Agreement.

**Dependent Software.** The software, network services or other products other than Software upon which the Software's performance depends on might be interrupted or discontinued at the discretion of the suppliers (software suppliers, service providers or Sony).

**High Risk Activities.** The Software is not fault-tolerant and is not designed, manufactured or intended for use or resale as on-line control equipment in hazardous environments requiring fail-safe performance, such as in the operation of nuclear facilities, aircraft navigation or communication systems, air traffic control, direct life support machines, or weapons systems, in which the failure of the Software could lead to death, personal injury, or severe physical or environmental damage ("High Risk Activities"). Sony and its suppliers specifically disclaim any express or implied warranty of fitness for High Risk Activities.

**GNU General Public, Lesser General Public, & Other Licenses.** Notwithstanding terms in this Agreement, certain portions of the Software are governed by the GNU Lesser General Public License, Version 2.1 (LGPL), GNU General Public License Version 2 (GPL), and other open source code licenses ("Open Source Licenses"), copies of which are attached hereto and incorporated herein. For such portions of the Software, to the extent there is any conflict between this Agreement and the Open Source Licenses, the Open Source Licenses shall govern as applicable.

**Certain Source Code Availability.** Sony is making available the source code of certain portions of the SOFTWARE per the GPL/LGPL LICENSES. Please see <http://www.sony.com/linux> for access to and instructions on obtaining such source code.

## **5. Changes to Service**

Sony reserves the right to discontinue one, some, or all of the features of the Service you receive at any time at its discretion. Sony may, at its discretion and from time to time change, add or remove features and functionality, upgrade or modify the Service, Site and/or Software without notice. You may, at Sony's discretion, receive messages regarding these changes and new features/functionality. Any new text, content, file, data, product, services, information, software, software tool or other feature provided by Sony (through the network or by CD-ROM or other means)(including, but not limited to, any update to Software provided to you automatically pursuant to Section 3 of this Agreement) will be subject to this Agreement; provided that, if separate terms and conditions applicable to such feature are provided to you, such terms and conditions shall apply to such feature in priority to this Agreement.

## **6. Confidentiality**

You shall maintain the confidentiality of any information with regard to the Product and Documentation that is provided under this Agreement and is not publicly known. You agree not to disclose such information to any third party without the prior written consent.

## **7. Export Control**

You agree not to export from anywhere the Software or thereof provided to you except in compliance with, and with all licences and approvals required under, applicable export laws, rules and regulations.

## **8. Sony's Right to Terminate or Modify Terms or Conditions of this Agreement**

Sony may add to, change, or remove any part, term, or condition of this Agreement at any time, without prior notice. Any changes to this Agreement or any terms posted on the Service and/or Site apply as soon as they are posted. By continuing to use the Service, Product, Software and/or Site after any changes are posted, you are indicating your acceptance of those changes. SONY MAY ADD, CHANGE, DISCONTINUE, REMOVE, OR SUSPEND ANY OTHER CONTENT POSTED ON THE SERVICE AND/OR SITE, INCLUDING FEATURES AND SPECIFICATIONS OF PRODUCTS DESCRIBED OR DEPICTED ON THE SERVICE AND/OR SITE, TEMPORARILY OR PERMANENTLY, AT ANY TIME, WITHOUT NOTICE AND WITHOUT LIABILITY. WITHOUT PREJUDICE TO ANY OTHER RIGHTS, SONY MAY SUSPEND OR TERMINATE THIS AGREEMENT IMMEDIATELY UPON NOTICE IF YOU FAIL TO COMPLY WITH THE TERMS AND CONDITIONS OF THIS AGREEMENT. Upon termination, you shall destroy the Software within fourteen (14) days after the date of such termination, and upon Sony's request, provide Sony with the certification of such destruction. Sony may take any legal and technical remedies to prevent the violation of and/or to enforce this Agreement, including without limitation, immediate termination of your access to the Service if we believe in our discretion you are violating this Agreement.

## **9. Indemnification**

You agree to indemnify, defend, and hold Sony and all of its agents, directors, employees, information providers, licensors and licensees, affiliates, content providers, officers, and parent (collectively, "Indemnified Parties"), harmless from and against any and all liability and costs (including, without limitation, attorneys' fees and costs), incurred by the Indemnified Parties in connection with any claim arising out of (i) any breach or alleged breach by you of this Agreement in any manner, (ii) any information you submit to Sony hereunder, (iii) any breach or alleged breach by you of a third party's rights or (iv) any damage caused by or alleged to have been caused by you to the Service. You will cooperate as fully as reasonably required in Indemnified Party(s) defense of any claim. Sony and/or Indemnified Parties reserve the right, at its own expense, to assume the exclusive defense and control of any matter otherwise subject to indemnification by you and you shall not in any event settle any matter without the written consent of Sony and/or Indemnified Parties.

## **10. DISCLAIMER OF WARRANTIES AND DAMAGES; LIMITATION OF LIABILITY**

YOU UNDERSTAND THAT USAGE OF THE PRODUCT AND SERVICE REQUIRES INTERNET SERVICE PROVIDED BY YOU, FOR WHICH YOU ARE SOLELY RESPONSIBLE. OPERATION OF THE PRODUCT AND/OR SERVICE MAY BE LIMITED OR RESTRICTED DEPENDING UPON THE CAPABILITIES OR TECHNICAL LIMITATIONS OF YOUR INTERNET SERVICE.

YOUR USE OF THE SOFTWARE, SERVICE, PRODUCT, CONTENT AND/OR SITE IS AT YOUR OWN RISK. THE SOFTWARE, SERVICE, CONTENT AND SITE ARE PROVIDED "AS IS" AND, TO THE FULLEST EXTENT PERMISSIBLE BY LAW, SONY MAKES NO REPRESENTATIONS OR WARRANTIES OF ANY KIND WHATSOEVER (1) FOR THE ACCURACY, MERCHANTABILITY, FITNESS FOR A PARTICULAR PURPOSE, OR NON-INFRINGEMENT ASSOCIATED WITH THE SERVICE, SITE, AND/OR SOFTWARE; (2) THAT THE SERVER(S) THAT MAKES THE SERVICE, SOFTWARE, AND/OR SITE AVAILABLE ARE FREE OF VIRUSES OR OTHER COMPONENTS THAT MAY INFECT, HARM, OR CAUSE DAMAGE TO YOUR COMPUTER, TELEVISION, OTHER EQUIPMENT, OR ANY OTHER PROPERTY. FURTHERMORE, SONY DOES NOT WARRANT OR MAKE ANY REPRESENTATIONS REGARDING THE USE OR THE RESULTS OF THE USE OF THE SOFTWARE, SERVICE, AND/OR SITE IN TERMS OF ITS CORRECTNESS, ACCURACY, RELIABILITY, OR OTHERWISE. NO ORAL OR WRITTEN INFORMATION OR ADVICE GIVEN BY SONY OR A SONY AUTHORIZED REPRESENTATIVE SHALL CREATE A WARRANTY OR IN ANY WAY INCREASE THE SCOPE OF THIS WARRANTY. SHOULD THE SOFTWARE, SERVICE, AND/OR SITE PROVE DEFECTIVE YOU (AND NOT SONY OR A SONY AUTHORIZED REPRESENTATIVE) ASSUME THE ENTIRE COST OF ALL NECESSARY SERVICING, REPAIR OR CORRECTION.

UNDER NO CIRCUMSTANCES, INCLUDING BUT NOT LIMITED TO SONY'S NEGLIGENCE OR ISSUES RELATED TO THIRD PARTY CONTENT PROVIDERS, SHALL SONY BE LIABLE FOR ANY CONSEQUENTIAL, DIRECT, INCIDENTAL, INDIRECT, PUNITIVE, OR SPECIAL DAMAGES RELATED TO (A) THE USE OF, (B) THE INABILITY TO USE, OR (C) ERRORS OR OMISSIONS IN THE SOFTWARE, SERVICE, PRODUCT, AND/OR SITE, EVEN IF SONY OR AN AUTHORIZED REPRESENTATIVE THEREOF HAS BEEN ADVISED OF THE POSSIBILITY OF SUCH DAMAGES. SOME STATES DO NOT ALLOW THE EXCLUSION OR LIMITATION OF CONSEQUENTIAL OR INCIDENTAL DAMAGES, SO THE ABOVE LIMITATION OR EXCLUSION MAY NOT APPLY TO YOU. IN NO EVENT SHALL SONY'S TOTAL LIABILITY TO YOU FOR ALL DAMAGES, LOSSES, AND CAUSES OF ACTION (WHETHER IN CONTRACT OR TORT, INCLUDING, BUT NOT LIMITED TO, NEGLIGENCE OR OTHERWISE) EXCEED THE AMOUNT PAID FOR THE PRODUCT.

SOME STATES, TERRITORIES AND COUNTRIES DO NOT ALLOW CERTAIN WARRANTY EXCLUSIONS, SO TO THAT EXTENT THE ABOVE DISCLAIMER AND LIMITATION OF LIABILITY MAY NOT APPLY TO YOU.

THE TERMS OF THIS DISCLAIMER DO NOT AFFECT OR PREJUDICE YOUR STATUTORY RIGHTS AS CONSUMER, NEITHER DO THEY LIMIT OR EXCLUDE ANY LIABILITY FOR DEATH OR PERSONAL INJURY CAUSED BY THE NEGLIGENCE OF SONY OR ANY OTHER LIABILITY IF AND TO THE EXTENT THAT IT CANNOT BE LIMITED OR EXCLUDED BY APPLICABLE LAW .

## 11. General Provisions

This Agreement, the limited warranty accompanying the Product, plus any additional terms posted on the Service or Site, together constitute the entire agreement between Sony and you with respect to your use of the Product, Service, Site, Content, and Software. Any notice by Sony hereunder may be made by letter, email, or posting on the Service or Site. Any cause of action you may have with respect to your use of this Site must be commenced within one (1) year after the claim or cause of action arises. If for any reason a court of competent jurisdiction finds any provision of this Agreement, or portion thereof, to be unenforceable, that provision shall be enforced to the maximum extent permissible so as to affect the intent of this Agreement, and the remaining terms and conditions of the Agreement shall continue in full force and effect. This Agreement shall be governed by and construed in accordance with the laws of Japan.

## Glossary

### AACS

“Advanced Access Content System” is a specification for managing digital entertainment contents stored on the next generation of prerecorded and recorded optical media. The specification enables consumers to enjoy digital entertainment content, including high-definition content.

### AVCHD (page 76)

The AVCHD format is a high definition digital video camera format used to record SD (standard definition) or HD (high definition) signals of either the 1080i specification\*<sup>1</sup> or the 720p specification\*<sup>2</sup> on DVDs, using efficient data compression coding technology. The MPEG-4 AVC/H.264 format is adopted to compress video data, and the Dolby Digital or Linear PCM is used to compress audio data. The MPEG-4 AVC/H.264 format is capable of compressing images at higher efficiency than that of the conventional image compression format. The MPEG-4 AVC/H.264 format enables a high definition (HD) video signal shot on a digital video camera recorder to be recorded on DVDs in the same way as for a standard definition (SD) television signal.

\*<sup>1</sup> A high definition specification that utilises 1080 effective scanning lines and the interlace format.

\*<sup>2</sup> A high definition specification that utilises 720 effective scanning lines and the progressive format.

### BD-J application

The BD-ROM format supports Java for interactive functions.

“BD-J” offers content providers almost unlimited functionality when creating interactive BD-ROM titles.

### BD-R (page 74)

BD-R (Blu-ray Disc Recordable) is a recordable, write-once Blu-ray Disc, available in the same capacities as the BD below. Since contents can be recorded and cannot be overwritten, a BD-R can be used to archive valuable data or storing and distributing video material.

### **BD-RE (page 74)**

BD-RE (Blu-ray Disc Rewritable) is a recordable and rewritable Blu-ray Disc, available in the same capacities as the BD below. The re-recordable feature makes extensive editing and time-shifting applications possible.

### **BD-ROM (page 74)**

BD-ROMs (Blu-ray Disc Read-Only Memory) are commercially produced discs and are available in the same capacities as the BD below. Other than conventional movie and video contents, these discs have enhanced features such as interactive content, menu operations using pop-up menus, selection of subtitle display, and slideshow. Although a BD-ROM may contain any form of data, most BD-ROM discs will contain movies in High Definition format, for playback on Blu-ray Disc/DVD players.

### **Blu-ray Disc (BD) (page 74)**

A disc format developed for recording/playing high-definition (HD) video (for HDTV, etc.), and for storing large amounts of data. A single layer Blu-ray Disc holds up to 25 GB, and a dual-layer Blu-ray Disc holds up to 50 GB of data.

### **Deep Colour (page 53)**

These are video signals for which the colour depth of signals passing through an HDMI jack have been enhanced. With a Non-Deep Colour-compatible player, the number of colours 1 pixel can express is 8 bits per component video signal (Y, Pb/Cb, Pr/Cr) (24 bits/16,777,216 colours). However, with a Deep Colour-compatible player, 1 pixel can express more bits, such as 12 bits per component video signal (Y, Pb/Cb, Pr/Cr) (36 bits). With more bits, the gradation of colour depth can be expressed more finely, and continuous colour changes will be displayed more smoothly.

### **DLNA (page 47, 66)**

The “Digital Living Network Alliance” is a non-profit organization that formulates DLNA Interoperability Guidelines for sharing digital content via a network. For details, visit the following website: <http://www.dlna.org/>

### **Dolby Digital Plus (page 77)**

Developed as an extension to Dolby Digital, the audio coding technology supports 7.1 multi-channel surround sound.

### **Dolby TrueHD (page 77)**

Dolby TrueHD is a lossless coding technology that supports up to 8 channels of multi-channel surround sound for the next generation optical discs. The reproduced sound is true to the original source bit-for-bit.

### **DTS-HD High Resolution Audio (page 77)**

Developed as an extension to DTS Digital Surround format. It supports a maximum sampling frequency of 96 kHz, and 7.1 multi-channel surround. DTS-HD High Resolution Audio has a maximum transmission rate of 6 Mbps, with lossy compression (Lossy).

### **DTS-HD Master Audio (page 77)**

DTS-HD Master Audio has a maximum transmission rate of 24.5 Mbps, and uses lossless compression (Lossless), and DTS-HD Master Audio corresponds to a maximum sampling frequency of 192 kHz, and maximum of 7.1ch.

### **HDMI (High-Definition Multimedia Interface) (page 17)**

HDMI is an interface that supports both video and audio on a single digital connection. The HDMI connection carries standard- to high-definition video signals and multi-channel audio signals to AV components such as HDMI equipped TVs, in digital form without degradation.

The HDMI specification supports HDCP (High-bandwidth Digital Contents Protection), a copy protection technology for digital entertainment contents for HDMI.

### **HD Reality Enhancer (HDMI) (page 41, 45)**

Sony-developed technology provides real-time parsing pixel-by-pixel, performs optimum smoothing, clarifies details, removes noise and achieves smoother gradation in video signals during playback.

### **LTH (Low to High) (page 75)**

LTH is a recording system that supports organic pigment type BD-R.

**PhotoTV HD (page 46)**

“PhotoTV HD” allows for a highly-detailed pictures, and photo-like expression of subtle textures and colours. By connecting Sony “PhotoTV HD” compatible devices using an HDMI cable, whole new world of photos can be enjoyed in breathtaking Full HD quality. For instance, the delicate texture of the human skin, flowers, sand and waves can now be displayed on a large screen in beautiful photo-like quality.

**Pop-up menu (page 38)**

An enhanced menu operation available on BD-ROMs. The pop-up menu appears when POP UP/MENU is pressed during playback, and can be operated while playback is in progress.

**Super Bit Mapping (page 53)**

It is possible to achieve smoother gradation by putting 14 bits of information into an 8-bit video signal. This Sony-developed technology takes into account human vision characteristics.

**Wi-Fi Protected Setup (page 27, 33)**

The Wi-Fi Protected Setup specification easily sets the security of wireless home networks.

There are 2 ways to use the Wi-Fi Protected Setup function:

- The Push Button Configuration method, using the WPS button on the wireless LAN router (access point)
- The PIN method, using a PIN code

**x.v.Colour (page 53)**

x.v.Colour is a familiar term for the xvYCC standard proposed by Sony.

xvYCC is an international standard for colour space in video.

This standard can express a wider colour range than the currently used broadcast standard.

**24p True Cinema (page 52)**

Movies shot with a film camera consist of 24 frames per second.

Since conventional televisions (both CRT and flat panels) display frames either at 1/60 or 1/50 second intervals, the 24 frames do not appear at an even pace.

When connected to a TV with 24p capabilities, the player displays each frame at 1/24 second intervals — the same interval originally shot with the film camera, thus faithfully reproducing the original cinema image.

---

# Index

Words in quotations appear in the on-screen displays.

## Numerics

24p True Cinema 85

## A

AACS 83

ANGLE 10

AUDIO 10

“Audio Output Priority” 54

Audio output signals 77

“Audio Settings” 42, 54

“Auto Power Off” 62

AVCHD 76, 83

## B

Batteries 29

“BD Data” 39

“BD/DVD Viewing Settings” 59

BD-LIVE 26, 38

BD-R 74, 83

BD-RE 74, 84

Bitstream 70

Blu-ray Disc 74, 84

BONUSVIEW 38

BRAVIA Sync 18, 71

## C

CD 74

“Chapter Search” 40

Child Lock 12, 72

Colour buttons 11

Connecting

AV amplifier  
(receiver) 21

TV 16

“Control for HDMI” 18, 37, 61, 71

## D

Deep Colour 53, 84

“Dimmer” 61

Disc Lock 37

DISPLAY 11

DLNA 47, 66, 84

Dolby Digital 23, 57

Dolby Digital Plus 77, 84

Dolby TrueHD 77, 84

DTS 23, 57

DTS-HD 77, 84

DVD 74

## E

Easy Setup 31, 67

Enter characters 65

External memory 26, 38, 72

## F

Freeze frame 11

Front panel display 13

## H

HD Audio 77

“HD Reality Enhancer (HDMI)” 41, 45, 84

HDMI 17, 22, 31, 51, 52, 53, 54, 57, 71, 84

“Headphones Type” 42

HOME 11, 36, 48

Home menu 48

## L

Language Follow 18

Local storage 26, 38, 72

LTH 84

## M

MAC address 62

MP3 audio tracks 43, 74

MULTI CHANNEL

OUTPUT 24, 54

“Music” 43

## N

“Network Settings” 63

“Network Update” 28, 49

## O

One-Touch Play 18, 37

OPTIONS 11, 38, 43, 45

“OSD” 61

## P

Parental Control 37, 59

“Photo” 44

“Photo Settings” 61

PhotoTV HD 46, 85

Play information 40

Playable discs 74

POP UP/MENU 11, 38

## Q

“Quick Start Mode” 61

## R

Region code 75

Remote 10, 29, 30

“Resetting” 68

Resetting the player 68

Resume 11, 37, 44

## S

SCENE SEARCH 11, 39

Self-diagnosis function 73

“Setup” 48

Slideshow 44, 46, 47

Slow-motion play 11

Software update 28, 49, 62

“Speaker Settings” 54

SUBTITLE 10

Super Bit Mapping 53, 85

SURROUND 42

System Power-Off 18

“System Settings” 61

## T

THEATRE 10, 18

“Title Search” 40

TOP MENU 11, 38

Troubleshooting 69

“TV Type” 50

## **U**

Update 28, 49

USB 46

## **V**

“Video” 36

Video output resolution 76

“Video Settings” 41, 50

## **W**

WEP 34, 63, 78

WEP key 34, 63

Wi-Fi Protected Setup 27,  
33, 63, 85

WPA key 34, 63

WPA2-PSK (AES) 78

WPA-PSK (AES) 78

WPA-PSK (TKIP) 78

WPS button 27, 33

## **X**

x.v.Colour 53, 85